



UFO Collimator

Features

- Ultra compact high efficiency LED collimator for Luxeon®* Lambertian LED light sources
- 17 mm diameter, < 10 mm tall from LED bottom surface
- Patented folded optics aspheric design
- Applications: Signaling, automotive lighting, architectural light, emergency lights, flashlights, general illumination

* www.luxeon.com, www.lumiledsfuture.com



Optical Performance

- >75% Total Efficiency (in 60 deg full angle cone)
- 12 deg FWHM collimation angle (varies slightly with LED colour)
- On axis intensity 12 cd/lm (varies slightly with LED colour)

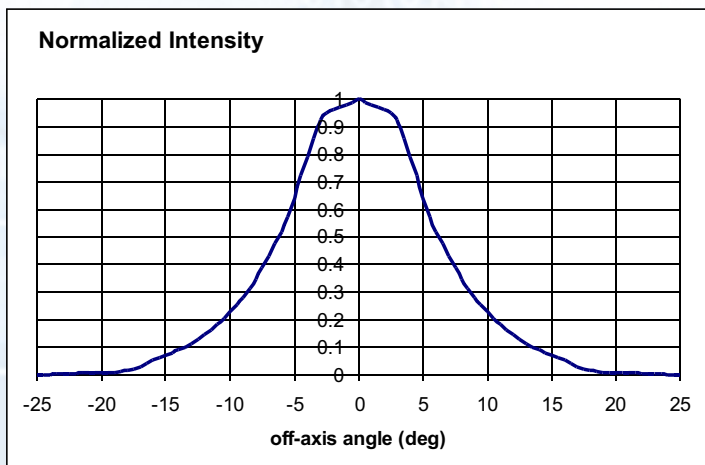

Dimensions

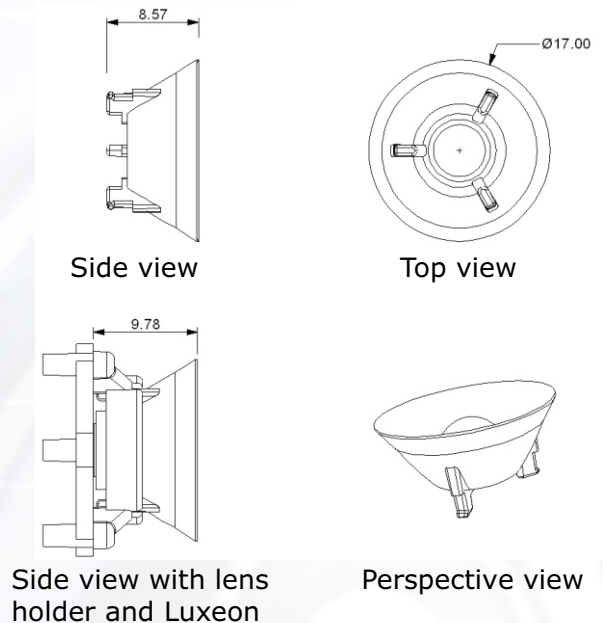

Light Sources

- UFO collimators are designed for:
Luxeon I and Luxeon III Lambertian emitters all colours
Luxeon I and Luxeon III Lambertian Star Hex all colours

- Lumileds Part numbers
LXHL-L?3C, LXHL-P?09, LXHL-P?01, LXHL-M?1D

Fill in "?" according to colour code of Lumileds part number

LPI part number: UFO1712LL01

Release date: 03/06 DS UFO001



LPI-Europe: +34
Marques de Urquijo, 14, 5ºD
28008 Madrid, Spain
Main 917 580680
Fax 915 596082

LPI-LLC USA: +1
2400 Lincoln Avenue
Altadena, CA 91001
Main 626 296 6493
Fax 626 296 6488

LPI-PO: +852
LPI Precision Optics Limited
Unit 02, G/F, Photonics Centre
2 Science Park East Avenue,
Hong Kong Science Park, Shatin, N.T.
Main 2428 8812
Fax 2144 2566

Enquiry: info@lpi-llc.com

Website: www.lpi-llc.com



UFO Holder

Features

- Holder for 17 mm UFO
- Holder precisely positions UFO collimator with respect to Luxeon LED
- UFO collimator snaps firmly into holder, simple to assemble
- Holder has three feet that fit into half moons of Luxeon Star Hex
- Holder slides into three holes on a 18.5 mm diameter circle (Holder A) or on a 18.16 mm diameter circle (Holder B). See drawing
- Recommended hole size: 2.5 mm
- Holder and lens have smaller diameters than Luxeon Star Hex



Holder A for:

- Luxeon 1W Star Hex
- Luxeon 1W emitter (mounted on custom PCB)
- Luxeon 3W emitter (mounted on custom PCB)

Holder B for:

- Luxeon 3W Star Hex

Holder A

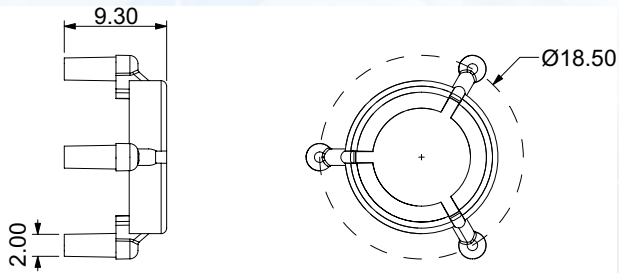

Side view

Top view

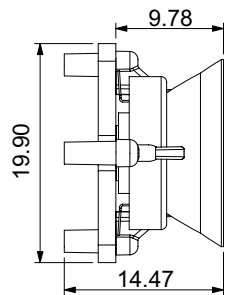

Side view with lens holder and Luxeon Star

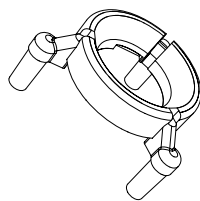

Perspective view

All dimensions in mm

Holder B

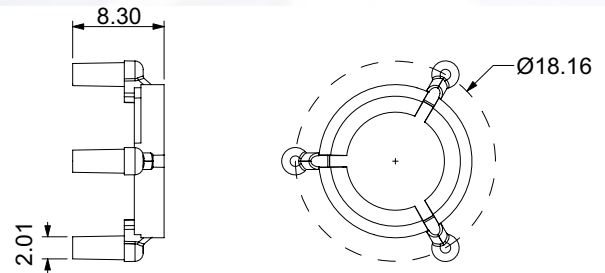

Side view

Top view

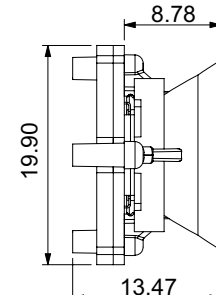

Side view with lens holder and Luxeon Star

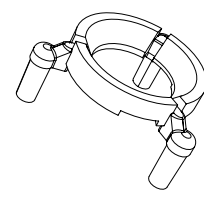

Perspective view

All dimensions in mm

LPI part number Holder A: HA-UFO17LL001

LPI part number Holder B: HB-UFO17LL001

Release date: 03/06 DS UFO001



LPI-Europe: +34
 Marques de Urquijo, 14, 5ºD
 28008 Madrid, Spain
 Main 917 580680
 Fax 915 596082

LPI-LLC USA: +1
 2400 Lincoln Avenue
 Altadena, CA 91001
 Main 626 296 6493
 Fax 626 296 6488

LPI-PO: +852
 LPI Precision Optics Limited
 Unit 02, G/F, Photonics Centre
 2 Science Park East Avenue,
 Hong Kong Science Park, Shatin, N.T.
 Main 2428 8812
 Fax 2144 2566

Enquiry: info@lpi-llc.com

Website: www.lpi-llc.com