



SPECIFICATIONS FOR REFOND SURFACE MOUNT LED

Model: **RF-BNS150TS-CD**

Company Name: _____

Confirmed By
Customer: _____

DATE: _____

深圳市瑞豐光電子有限公司

SHENZHEN REFOND OPTOELECTRONICS CO.,LTD.

深圳市龍華和平西路特發高新科技園B2棟
B2 wing, Tefa Tech. Industry, West Heping Road,

Longhua Town, Shenzhen, China P.C:518109

TEL:0755-29675000

FAX:0755-29675111

<http://www.refond-led.com>

Feature

- ◆ Viewing angle:140 deg
- ◆ The materials of the LED dice is InGaN
- ◆ 3.20mm×1.60mm×0.70mm SMT-LED
- ◆ RoHS compliant lead-free soldering compatible

Package Outline

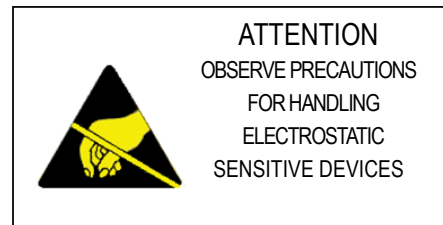
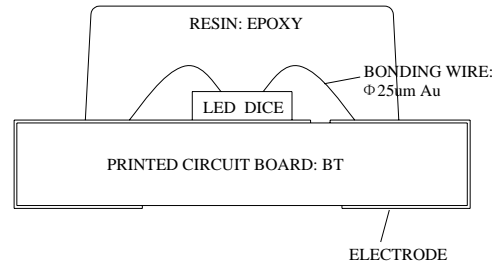
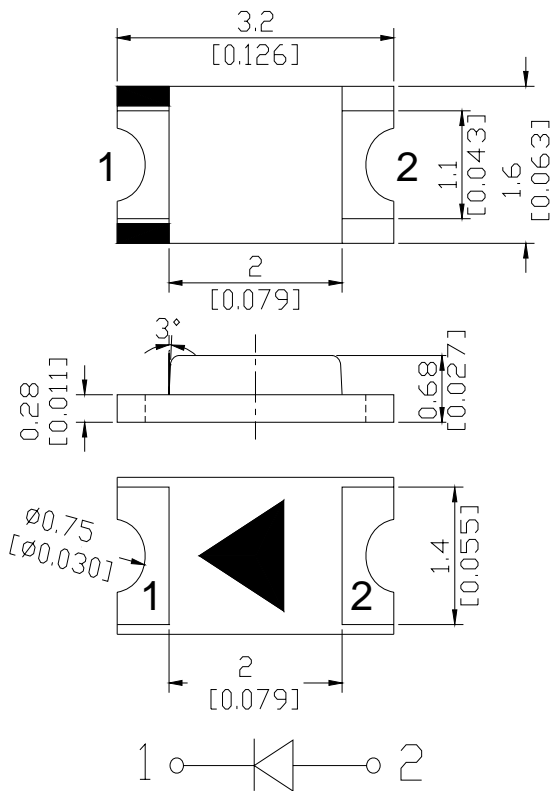

NOTES:

1. All dimensions are in millimeters (inches);
2. Tolerances are $\pm 0.1\text{mm}$ (0.004inch) unless otherwise noted.

| | | | | | |
|--------------|--|-------------|--|--------------|--|
| APPROVED BY: | | CHECKED BY: | | PREPARED BY: | |
| DATE: | | DATE: | | DATE: | |

Absolute maximum ratings at Ta=25°C

| Parameter | Symbol | Value | Unit |
|-----------------------------|-----------------|-----------|------|
| Power dissipation | Pd | 70 | mW |
| Forward current | If | 20 | mA |
| Reverse voltage | Vr | 5 | V |
| Operating temperature range | Top | -40 ~+100 | °C |
| Storage temperature range | Tstg | -40~+100 | °C |
| Peak pulsing current | I _{fp} | 100 | mA |
| Electrostatic Discharge | ESD | 1000(HBM) | V |

Electro-optical characteristics at Ta=25°C

| Parameter | Test Condition | Symbol | Value | | | Unit | |
|------------------------------|----------------|------------------|-------------|-------|------|---------|-----|
| | | | Min. | Typ. | Max. | | |
| Wavelength at peak emission | If=20mA | λ_{peak} | -- | -- | -- | nm | |
| Spectral Radiation bandwidth | If=20mA | $\Delta\lambda$ | -- | 30 | -- | nm | |
| Forward voltage | If=20mA | Vf | 3.0 | -- | 3.5 | V | |
| Dominant wavelength | Rank H | If=20mA | λ_d | 465 | -- | 467.5 | nm |
| | Rank I | If=20mA | λ_d | 467.5 | -- | 470 | nm |
| | Rank J | If=20mA | λ_d | 470 | -- | 472.5 | nm |
| | Rank K | If=20mA | λ_d | 472.5 | -- | 475 | nm |
| Luminous intensity | Rank E | If=20mA | Iv | 60 | -- | 90 | mcd |
| | Rank V | If=20mA | Iv | 90 | -- | 120 | mcd |
| | Rank W | If=20mA | Iv | 120 | -- | 140 | mcd |
| | Rank G | If=20mA | Iv | 140 | -- | 160 | mcd |
| Viewing angle at 50% Iv | If=20mA | 2 θ 1/2 | -- | 140 | -- | Deg | |
| Reverse current | Vr=5V | I _r | -- | -- | 10 | μ A | |

NOTE: (Tolerance: Iv \pm 10%, λ_d \pm 2nm, Vf \pm 0.05V)

IFP Conditions: Pulse Width \leq 10msec. and Duty \leq 1/10.

Typical optical characteristics curves

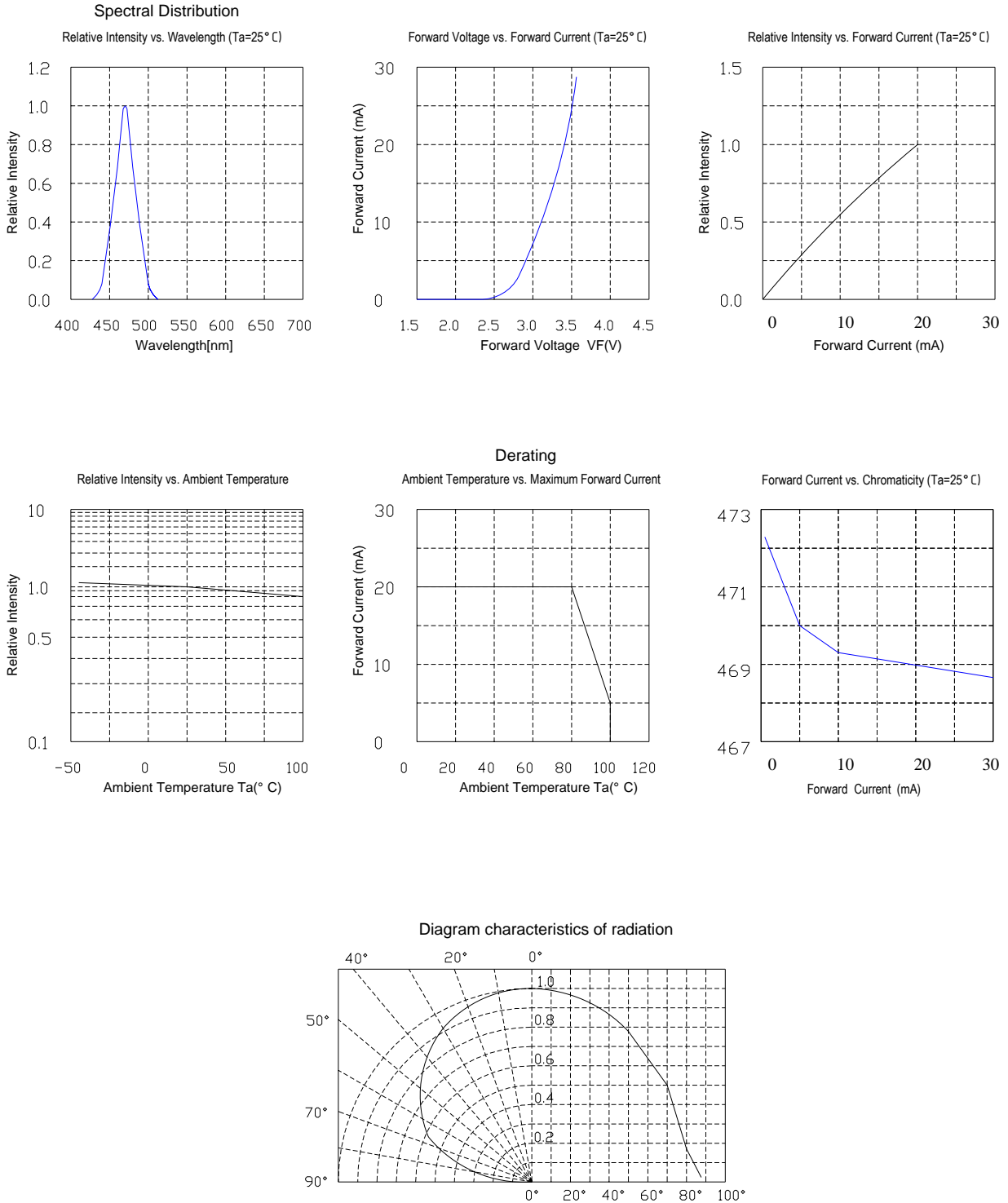

Reflow profile

■ Soldering condition

- Recommended soldering conditions

| Reflow Soldering | | Hand Soldering | |
|------------------|------------------------------|----------------|----------------------------------|
| Pre-heat | 160~180°C | Temperature | 300°C Max. |
| Pre-heat time | 120 seconds Max. | Soldering time | 3 second Max. (one time only) |
| Peak temperature | 260°C Max. | | |
| Soldering time | 10 seconds Max. | | |
| Condition | Refer to Temperature-profile | | |

- After reflow soldering rapid cooling should be avoided

■ Temperature-profile (Surface of circuit board)

Use the following conditions shown in the figure.

RECOMMEND PAD DESIGN (Units: mm)

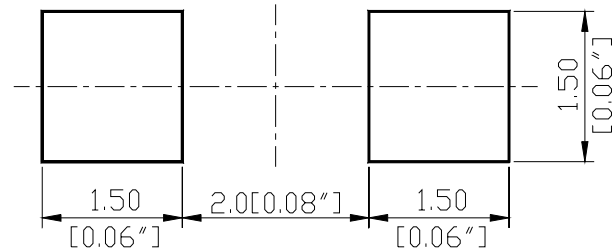
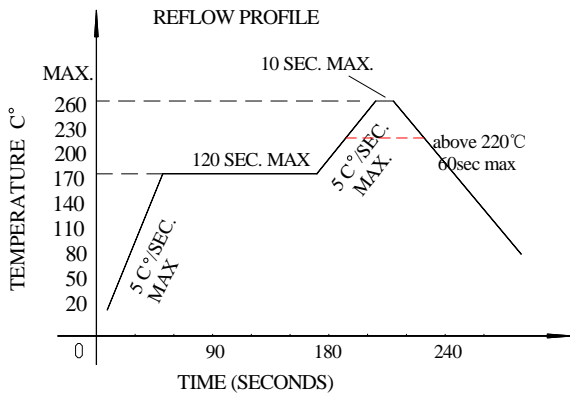

1. Reflow soldering should not be done more than two times
2. When soldering ,do not put stress on the LEDs during heating

■ Soldering iron

1. When hand soldering, keep the temperature of the iron under 300°C, and at that temperature keep the time under 3 sec.
2. The hand soldering should be done only a time
3. The basic spec is ≤ 5 sec. when the temperature of 260°C, do not contact the resin when hand soldering

■ Rework

1. Customer must finish rework within 5 sec under 260°C
2. The head of iron can not touch the resin
3. Twin-head type is preferred.

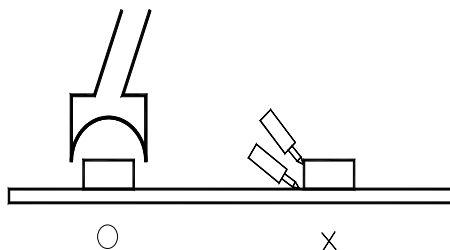



Reliability

(1)TEST ITEMS AND RESULTS

| Type | Test Item | Test Conditions | Note | Number of Damaged |
|------------------------|--|---|-----------|-------------------|
| Environmental Sequence | Resistance to Soldering Heat(Reflow Soldering) | Tsld=260°C, 10sec | 2 times | 0/22 |
| | Temperature Cycle | -40°C 30min ↑↓5min 100°C 30min | 100 cycle | 0/100 |
| | Thermal Shock | -40°C 15min ↑↓ 100°C 15min | 100 cycle | 0/100 |
| | High Temperature Storage | T _a =80°C | 1000 hrs | 0/100 |
| | Temperature Humidity Storage | T _a =60°C RH=90% | 1000 hrs | 0/100 |
| | Low Temperature Storage | T _a =-30°C | 1000 hrs | 0/100 |
| | Power on/off Cycle Test IF=20mA | On 2 hours ↑↓ Off 10min | 100 cycle | 0/100 |
| Operation Sequence | Life Test | T _a =25°C I _F =20mA | 1000 hrs | 0/100 |
| | High Humidity Heat Life Test | 60°C RH=90% I _F =20mA | 500 hrs | 0/100 |
| | Low Temperature Life Test | T _a =-20°C I _F =20mA | 1000 hrs | 0/100 |
| | Drop | 75cm | 3 times | 0/10 |

(2)CRITERIA FOR JUDGING THE DAMAGE

| Item | Symbol | Test Conditions | Criteria for Judgement | |
|--------------------|--------|-----------------|------------------------|-------------|
| | | | Min. | Max. |
| Forward Voltage | VF | IF=10mA | - | U.S.L*)×1.1 |
| Reverse Current | IR | VR=5V | - | U.S.L*)×2.0 |
| Luminous Intensity | IV | IF=10mA | L.S.L**)*×0.7 | - |

U.S.L.: Upper Standard Level

L.S.L.: Lower Standard Level



REFOND

Packaging Specifications

● Feeding Direction

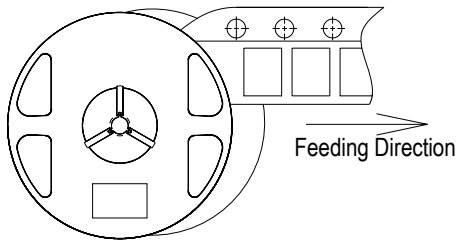

● Dimensions of Reel (Unit: mm)

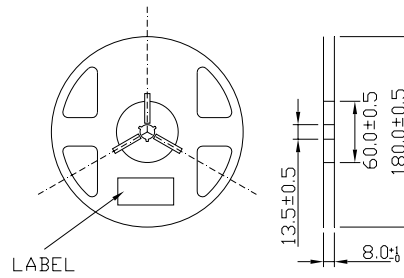

● Dimensions of Tape (Unit: mm)

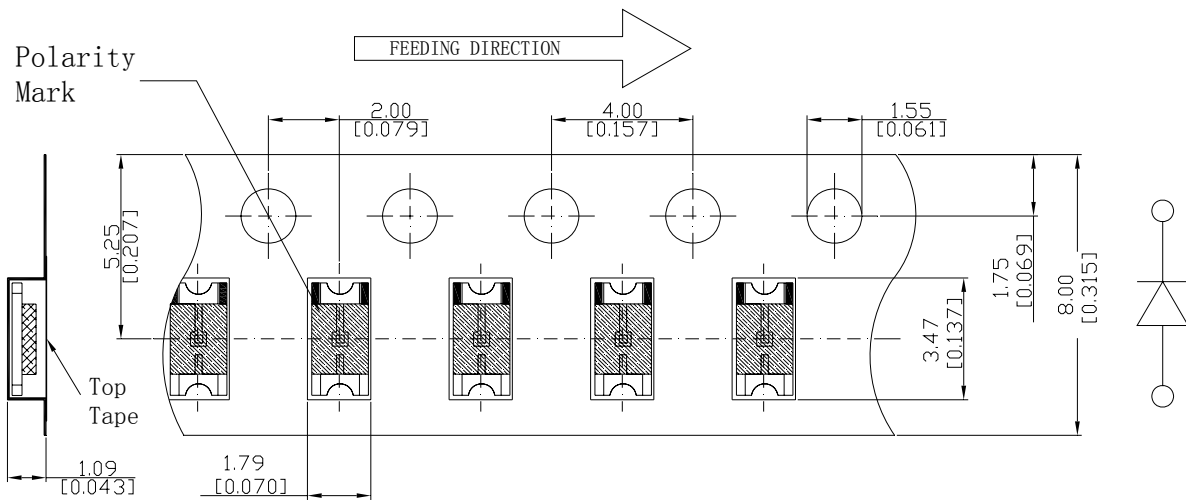

● Arrangement of Tape

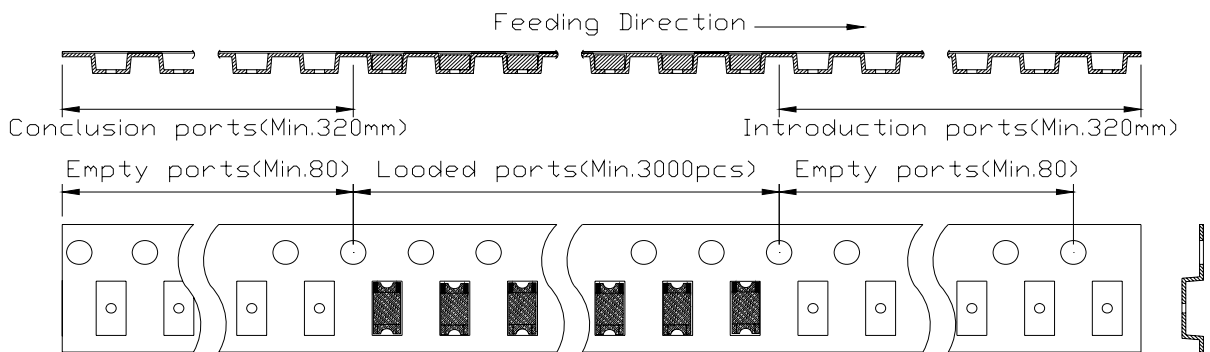



NOTES

1. Empty component pockets are sealed with top cover tape;
2. The maximum number of missing lamps is two;
3. The cathode is oriented towards the tape sprocket hole in accordance with ANSI/EIA RS-481 specifications.
4. 3,000 pcs/ Reel.

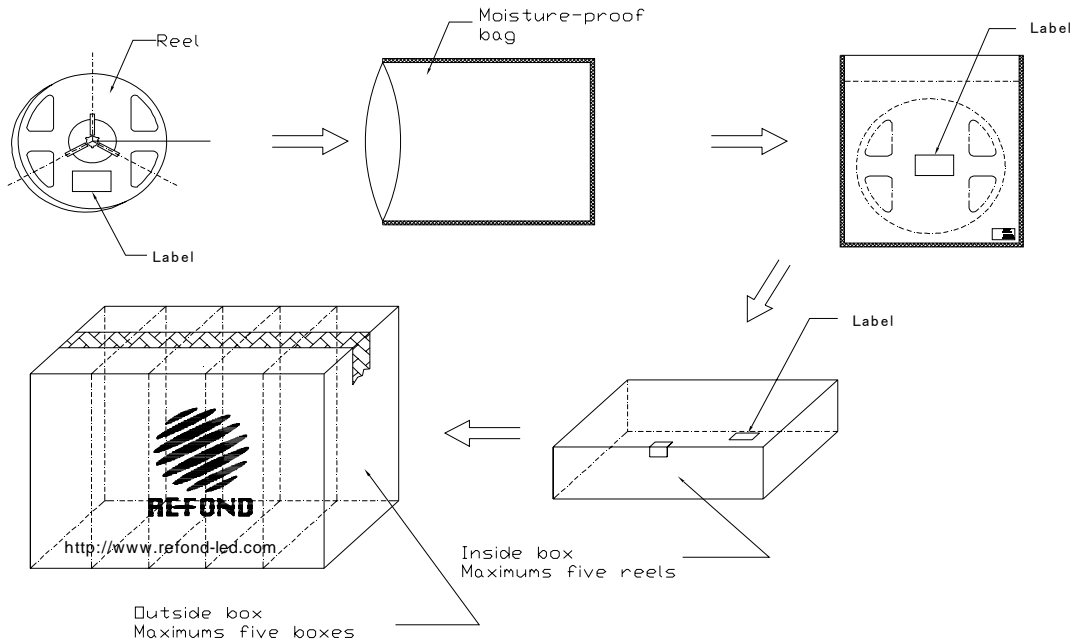
Packaging specifications



Label

| | |
|---|-----|
| PART NO. | |
| LOT NO. | |
|  | |
| QTY: | PCS |
| DATE: | |
|  | |

CAUTIONS

Package specifications

Reeled products (numbers of products are 3,000pcs) packed in a seal off moisture-proof bag along with a desiccant one by one, Five moisture-proof bag of maximums (total maximum number of products are 15,000pcs) packed in an inside box (size: about 250mm x about 250 x about 68mm) and Five inside boxes of maximums are put the outside box (size: about 360mm x about 265mm x about 255mm) Together with buffer material, and it is packed. (Part No., Lot No., quantity should appear on the label on the moisture-proof bag, part No. And quantity should appear on the label on the cardboard box.) The number of the loading steps of outside box (cardboard box) has three steps.

Storage conditions

Before opening the package:

The LEDs should be kept at 30°C or less and 90%RH or less. The LEDs should be used within a year. When storing the LEDs, moisture proof packaging with absorbent material (silica gel) is recommended.

After opening the package:

The LEDs should be kept at 30°C or less and 70%RH or less. The LEDs should be soldered within 168 hours (7days) after opening the package. If unused LEDs remain, they should be stored in moisture proof packages, such as sealed containers with packages of moisture absorbent material (silica gel). It is also recommended to return the LEDs to the original moisture proof bag and to reseal the moisture proof bag again.