

Specification

HPL-H44X₁X₂1C0



Features

- Dimension : 4.4mm(L)×4.4mm(W)
- 3W High Flux type
- All Metal Design Cu PCB/ Al reflector
- Low thermal resistance
- The InGaN or AlInGaP Chip inside
- Superior ESD protection

Applications

- Traffic signaling
- Backlighting
- Interior & exterior automotive lighting
- Decorative and landscape lighting
- Signage and channel letter
- Portable light source
- Decorating and entertainment lighting
- Architectural lighting
- Street lighting

5F, No 173-8, Yung-Fon Road, Tu-Cheng District, New Taipei City, Taiwan, R.O.C.
TEL: +886-2-8262-8886 FAX : +886-2-8262-8885

Table of Contents

General Information	3
Part Number Matrix	4
Absolute Maximum Ratings	5
Initial Electrical/Optical Characteristics.....	6
Forward Voltage.....	6
Reverse Current.....	6
Luminous Flux.....	7
Color Temperature or Dominate Wavelength.....	7
Color Rendering Index (CRI, Ra Value).....	8
Typical Radiation Pattern	9
Bin Code List for Reference	12
Hue Bin Code List for Reference	13
Hue Bin Specification for Red, Green, Blue, Amber, Orange	19
Part Number Formation.....	20
Characteristic Diagram	21
Outline Dimension.....	25
Pad Configuration	26
Recommended Solder Pattern.....	27
Shipping Package Style	28
Lens Type	28
Tapping Dimension Packaging Specification	28
Assembly Type.....	35
Tapping Dimension Packaging Specification	35
Qualification Reliability Testing.....	38
Recommended Solder Profile.....	39

General Information

HPL - H44X₁X₂1C0

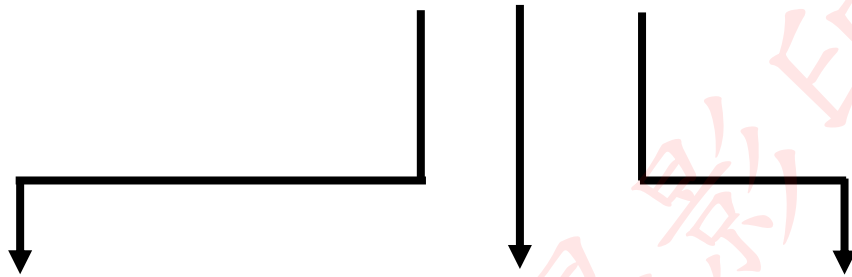

X1: Lens & Assembly Type-
R : Lens 60°
T : Lens 60° & Star
L : Lens 120°
F : Lens 120° & Star
D : Lens 30°
X : Lens 30° & Star

X2: Color-
W: Cool White
N: Neutral White
S: Warm White
R: Red
G: Green
B: Blue
A: Amber
O: Orange

Power-
C: 3W

Part Number Matrix

Type Color	30°Lens	30°Lens & Star	60°Lens	60°Lens & Star	120°Lens	120°Lens & Star
Cool White	HPL-H44DW1C0	HPL-H44XW1C0	HPL-H44RW1C0	HPL-H44TW1C0	HPL-H44LW1C0	HPL-H44FW1C0
Neutral White	HPL-H44DN1C0	HPL-H44XN1C0	HPL-H44RN1C0	HPL-H44TN1C0	HPL-H44LN1C0	HPL-H44FN1C0
Warm White	HPL-H44DS1C0	HPL-H44XS1C0	HPL-H44RS1C0	HPL-H44TS1C0	HPL-H44LS1C0	HPL-H44FS1C0
Red	HPL-H44DR1C0	HPL-H44XR1C0	HPL-H44RR1C0	HPL-H44TR1C0	HPL-H44LR1C0	HPL-H44FR1C0
Green	HPL-H44DG1C0	HPL-H44XG1C0	HPL-H44RG1C0	HPL-H44TG1C0	HPL-H44LG1C0	HPL-H44FG1C0
Blue	HPL-H44DB1C0	HPL-H44XB1C0	HPL-H44RB1C0	HPL-H44TB1C0	HPL-H44LB1C0	HPL-H44FB1C0
Amber	HPL-H44DA1C0	HPL-H44XA1C0	HPL-H44RA1C0	HPL-H44TA1C0	HPL-H44LA1C0	HPL-H44FA1C0
Orange	HPL-H44DO1C0	HPL-H44XO1C0	HPL-H44RO1C0	HPL-H44TO1C0	HPL-H44LO1C0	HPL-H44FO1C0

Absolute Maximum Ratings

(T_j=25°C)

Parameter		Symbol	Rating	Unit
Power Dissipation	Cool-White	P	2.66	W
	Neutral-White		2.66	
	Warm-White		2.66	
	Red		1.75	
	Green		2.66	
	Blue		2.66	
	Amber		1.75	
	Orange		1.75	
Forward Current		I _F	700	mA
Forward Pulse Current (1/10 Duty Cycle, 400msec Pulse Width)		I _{FP}	1000	mA
Thermal Resistance, Junction-Case		R _{th, J-C1}	10	°C/W
Reverse Voltage		V _R	5	V
LED Junction Temperature		T _J	125	°C
Operating Temperature Range		T _{opr}	- 40°C to + 80°C	
Storage Temperature Range		T _{stg}	- 40°C to + 120°C	
Soldering Condition		T _{sol}	260°C For 5 Seconds	

Note: 1. The thermal resistance value is measured with MCPCB (Star).

Initial Electrical/Optical Characteristics

- Forward Voltage**

(T_j=25°C)

Color	Forward Voltage					
	Symbol	MIN.	TYP.	MAX.	Test Condition	Unit
Cool-White→W	V _F	3.03	3.80	4.23	I _F = 700mA	V
Neutral-White→N	V _F	3.03	3.80	4.23	I _F = 700mA	V
Warm-White→S	V _F	3.03	3.80	4.23	I _F = 700mA	V
Red→R	V _F	1.83	2.50	3.03	I _F = 700mA	V
Green→G	V _F	3.03	3.80	4.23	I _F = 700mA	V
Blue→B	V _F	3.03	3.80	4.23	I _F = 700mA	V
Amber→A	V _F	1.83	2.50	3.03	I _F = 700mA	V
Orange→O	V _F	1.83	2.50	3.03	I _F = 700mA	V

- Reverse Current**

(T_j=25°C)

Color	Reverse Current					
	Symbol	MIN.	TYP.	MAX.	Test Condition	Unit
Cool-White→W	I _R	-	-	100	V _R = 5V	μA
Neutral-White→N	I _R	-	-	100	V _R = 5V	μA
Warm-White→S	I _R	-	-	100	V _R = 5V	μA
Red→R	I _R	-	-	100	V _R = 5V	μA
Green→G	I _R	-	-	100	V _R = 5V	μA
Blue→B	I _R	-	-	100	V _R = 5V	μA
Amber→A	I _R	-	-	100	V _R = 5V	μA
Orange→O	I _R	-	-	100	V _R = 5V	μA

● **Luminous Flux**

(T_j=25°C)

Color	Luminous Flux					
	Symbol	MIN.	TYP.	MAX.	Test Condition	Unit
Cool-White→W	Φ _v	-	170	-	I _F = 700mA	lm
Neutral-White→N	Φ _v	-	145	-	I _F = 700mA	lm
Warm-White→S	Φ _v	-	125	-	I _F = 700mA	lm
Red→R	Φ _v	-	75	-	I _F = 700mA	lm
Green→G	Φ _v	-	125	-	I _F = 700mA	lm
Blue→B	Φ _v	-	30	-	I _F = 700mA	lm
Amber→A	Φ _v	-	102	-	I _F = 700mA	lm
Orange→O	Φ _v	-	102	-	I _F = 700mA	lm

● **Color Temperature or Dominate Wavelength**

(T_j=25°C)

Color	Color Temperature or Dominate Wavelength					
	Symbol	MIN.	TYP.	MAX.	Test Condition	Unit
Cool-White→W	CCT	4500	5650	10000	I _F = 700mA	K
Neutral-White→N	CCT	3500	4000	4500	I _F = 700mA	K
Warm-White→S	CCT	2670	3000	3500	I _F = 700mA	K
Red→R	λ _d	620	-	630	I _F = 700mA	nm
Green→G	λ _d	520	-	535	I _F = 700mA	nm
Blue→B	λ _d	460	-	475	I _F = 700mA	nm
Amber→A	λ _d	585	-	595	I _F = 700mA	nm
Orange→O	λ _d	610	-	620	I _F = 700mA	nm

● Color Rendering Index (CRI, Ra Value)

(Tj=25°C)

Color	Color rendering Index					
	Symbol	MIN.	TYP.	MAX.	Test Condition	Unit
Cool-White→W	Ra		70	-	I _F = 700mA	-
Neutral-White→N			75	-	I _F = 700mA	-
Warm-White→S			80	-	I _F = 700mA	-

- **Typical Radiation Pattern**

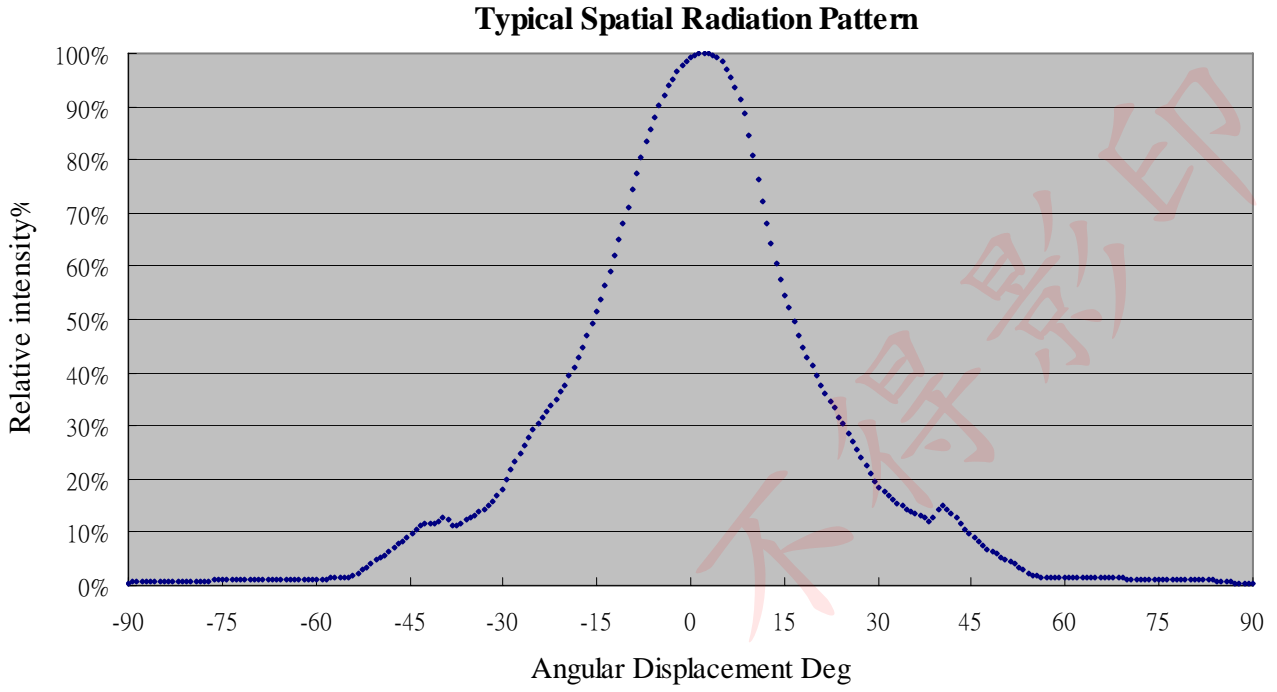

Fig. 1A(30° Lens) Typical Representative Spatial Radiation Pattern for Cool-White, Neutral-White and Warm-White .

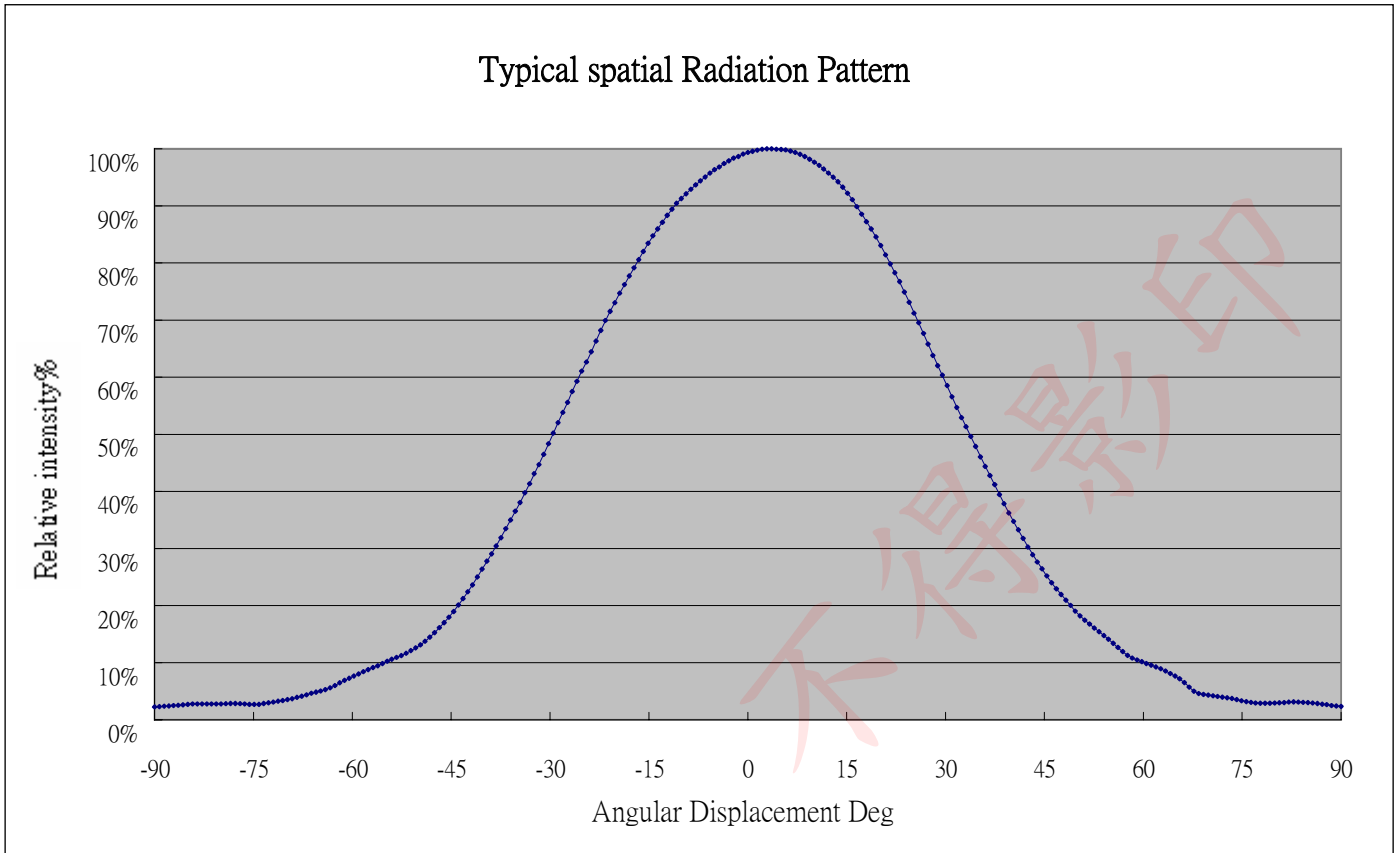

Fig. 1B(60° Lens) Typical Representative Spatial Radiation Pattern for Cool-White, Neutral-White and Warm-White .

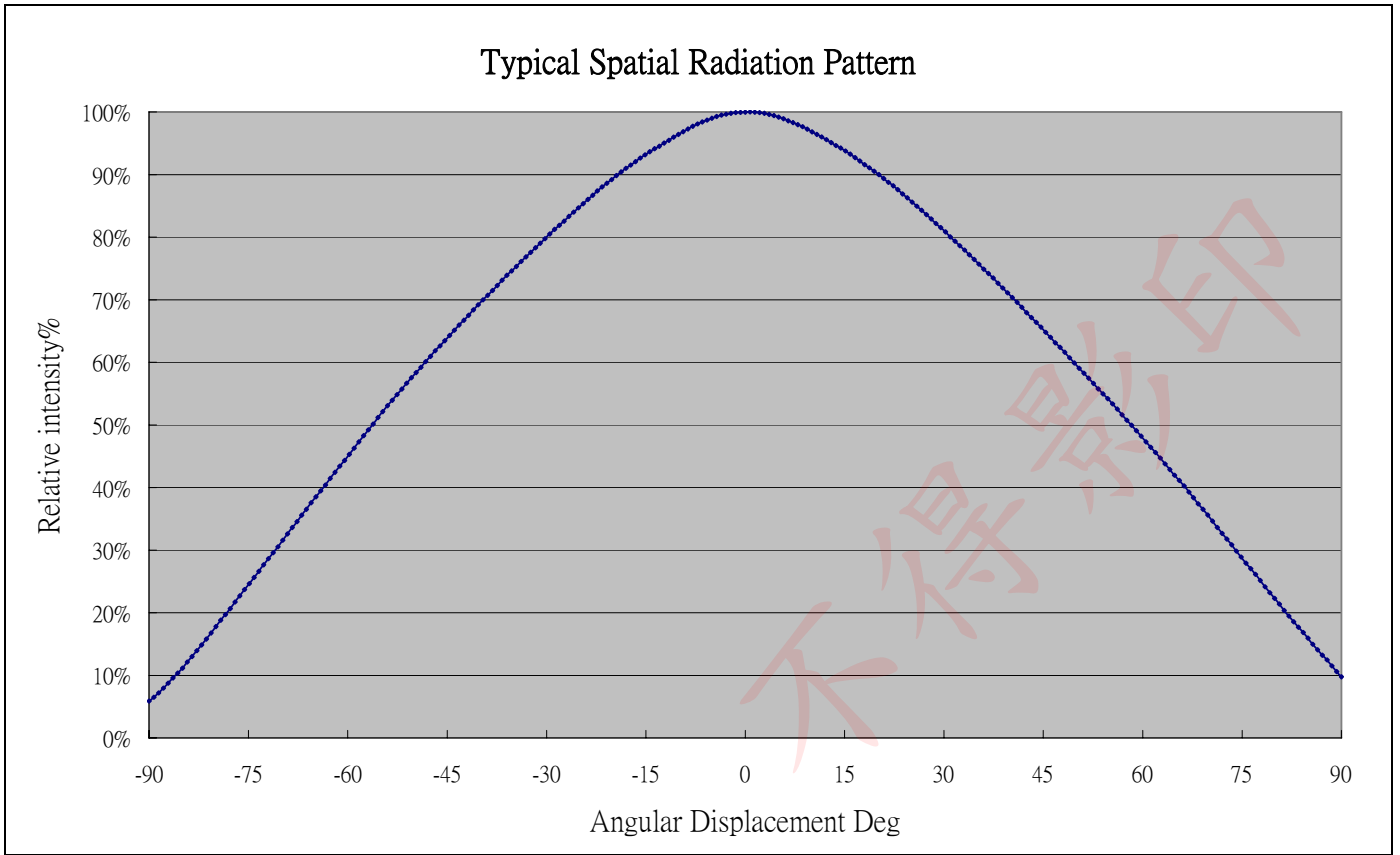

Fig. 1C(120° Lens) Typical Representative Spatial Radiation Pattern for Cool-White, Neutral-White and Warm-White .

● Bin Code List for Reference

(T_j=25°C)

Item	Bin Code	Symbol	Condition	Min.	Max.	Unit
Forward Voltage ¹	C	V _F	I _F = 700 [mA]	1.83	2.07	V
	D			2.07	2.31	
	E			2.31	2.55	
	F			2.55	2.79	
	G			2.79	3.03	
	H			3.03	3.27	
	J			3.27	3.51	
	K			3.51	3.75	
	L			3.75	3.99	
	M			3.99	4.23	
Luminous Flux ²	C	Φ _V	I _F = 700 [mA]	13.9	18.1	lm
	D			18.1	23.5	
	E			23.5	30	
	F			30	40	
	G			40	50	
	H			50	60	
	J			60	70	
	K			70	80	
	L			80	90	
	M			90	100	
	N			100	120	
	P			120	140	
	Q			140	160	
R	160	180				
S	180	200				

Note: 1. Forward voltage measurement allowance is ± 0.1V.

2. Luminous flux measurement allowance is ± 10%.

● Hue Bin Code List for Reference
Cool-White→W color

Bin Code	X	Y	CCT(K)	Bin Code	X	Y	CCT(K)	Bin Code	X	Y	CCT(K)
YO	0.2742	0.3007	7000~10000	WN	0.3148	0.3444	5650~6300	VP	0.3292	0.3313	5000~5650
	0.3031	0.3327			0.3288	0.3569			0.3444	0.3442	
	0.3076	0.3108			0.3290	0.3451			0.3434	0.3320	
	0.2830	0.2838			0.3160	0.3332			0.3294	0.3202	
YA	0.2830	0.2838	6300~7000	WO	0.3160	0.3332	4500~5000	UM	0.3481	0.3856	4500~5000
	0.3076	0.3108			0.3290	0.3451			0.3673	0.4003	
	0.3112	0.2932			0.3292	0.3313			0.3642	0.3829	
	0.2899	0.2703			0.3175	0.3204			0.3469	0.3717	
XM	0.3011	0.3422	6300~7000	WP	0.3175	0.3204	4500~5000	UN	0.3469	0.3717	4500~5000
	0.3136	0.3550			0.3292	0.3313			0.3642	0.3829	
	0.3148	0.3444			0.3294	0.3202			0.3622	0.3716	
	0.3031	0.3327			0.3186	0.3102			0.3458	0.3592	
XN	0.3031	0.3327	6300~7000	WQ	0.3186	0.3102	5000~5650	UO	0.3458	0.3592	5000~5650
	0.3148	0.3444			0.3294	0.3202			0.3622	0.3716	
	0.3160	0.3332			0.3295	0.3105			0.3594	0.3557	
	0.3052	0.3224			0.3196	0.3013			0.3444	0.3442	
XO	0.3052	0.3224	6300~7000	VM	0.3286	0.3690	5000~5650	UP	0.3444	0.3442	5000~5650
	0.3160	0.3332			0.3481	0.3856			0.3594	0.3557	
	0.3175	0.3204			0.3469	0.3717			0.3571	0.3426	
	0.3076	0.3108			0.3288	0.3569			0.3434	0.3320	
XP	0.3076	0.3108	6300~7000	VN	0.3288	0.3569	5000~5650	UP	0.3444	0.3442	5000~5650
	0.3175	0.3204			0.3469	0.3717			0.3594	0.3557	
	0.3196	0.3013			0.3458	0.3592			0.3571	0.3426	
	0.3112	0.2932			0.3290	0.3451			0.3434	0.3320	
WM	0.3136	0.3550	5650~6300	VO	0.3290	0.3451	5650~6300	UP	0.3444	0.3442	5650~6300
	0.3286	0.3690			0.3458	0.3592			0.3594	0.3557	
	0.3288	0.3569			0.3444	0.3442			0.3571	0.3426	
	0.3148	0.3444			0.3292	0.3313			0.3434	0.3320	

Cool-White Bin Structure

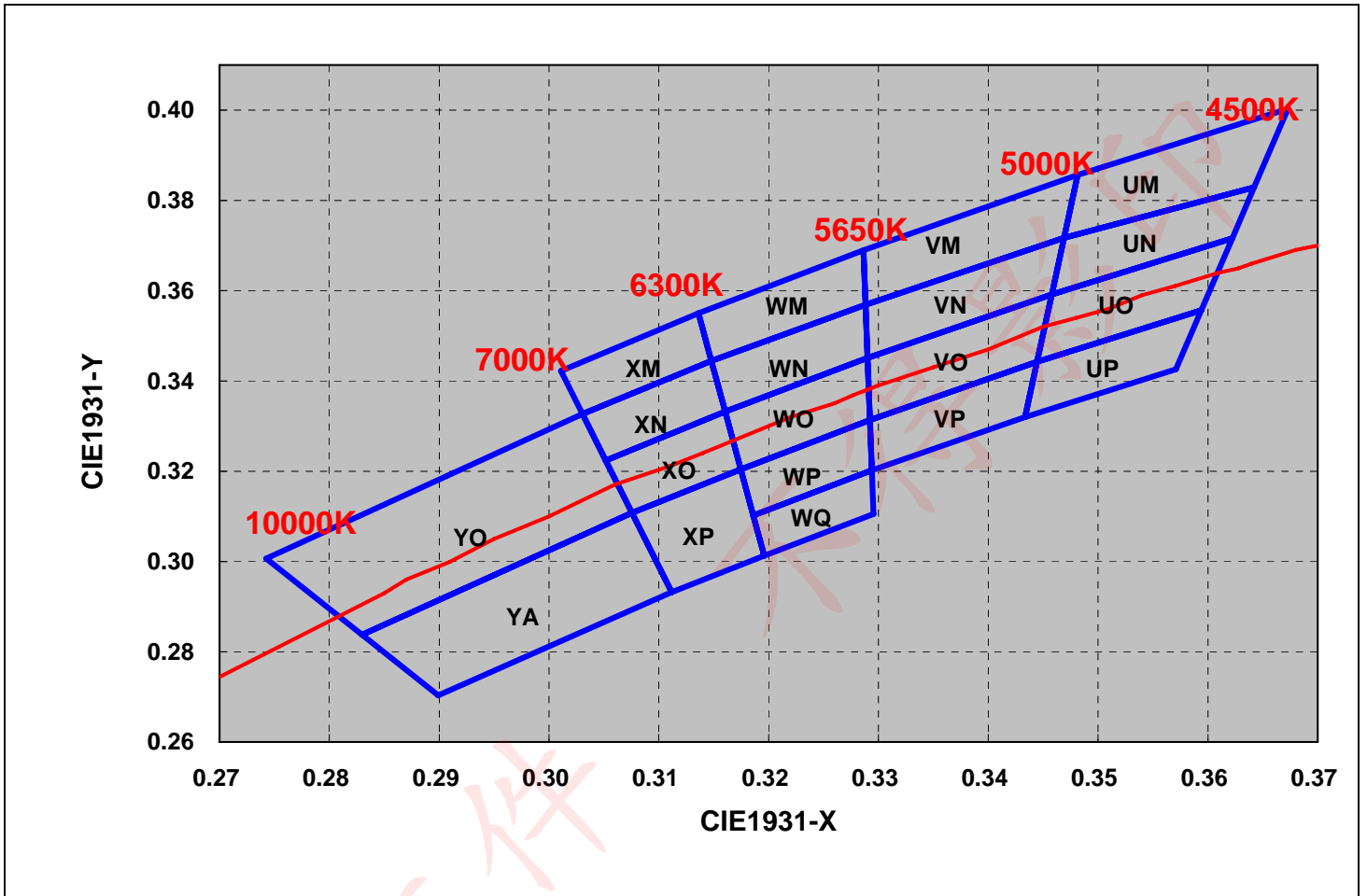

Fig. 2A Cool-White Bin Structure.

Neutral-White→N color

Bin Code	X	Y	CCT(K)	Bin Code	X	Y	CCT(K)	Bin Code	X	Y	CCT(K)
TM	0.3673	0.4003	4100~4500	SM	0.3860	0.4130	3800~4100	RM	0.4023	0.4228	3500~3800
	0.3860	0.4130			0.4023	0.4228			0.4209	0.4326	
	0.3811	0.3937			0.3963	0.4035			0.4148	0.4161	
	0.3642	0.3829			0.3811	0.3937			0.3963	0.4035	
TN	0.3642	0.3829		SN	0.3811	0.3937		RN	0.3963	0.4035	
	0.3811	0.3937			0.3963	0.4035			0.4148	0.4161	
	0.3783	0.3825			0.3924	0.3909			0.4086	0.3995	
	0.3622	0.3716			0.3783	0.3825			0.3924	0.3909	
TO	0.3622	0.3716		SO	0.3783	0.3825		RO	0.3924	0.3909	
	0.3783	0.3825			0.3924	0.3909			0.4086	0.3995	
	0.3741	0.3658			0.3871	0.3739			0.4021	0.3822	
	0.3594	0.3557			0.3741	0.3658			0.3871	0.3739	
TP	0.3594	0.3557		SP	0.3741	0.3658		RP	0.3871	0.3739	
	0.3741	0.3658			0.3871	0.3739			0.4021	0.3822	
	0.3706	0.3520			0.3826	0.3595			0.3966	0.3673	
	0.3571	0.3426			0.3706	0.3520			0.3826	0.3595	

Neutral-White Bin Structure

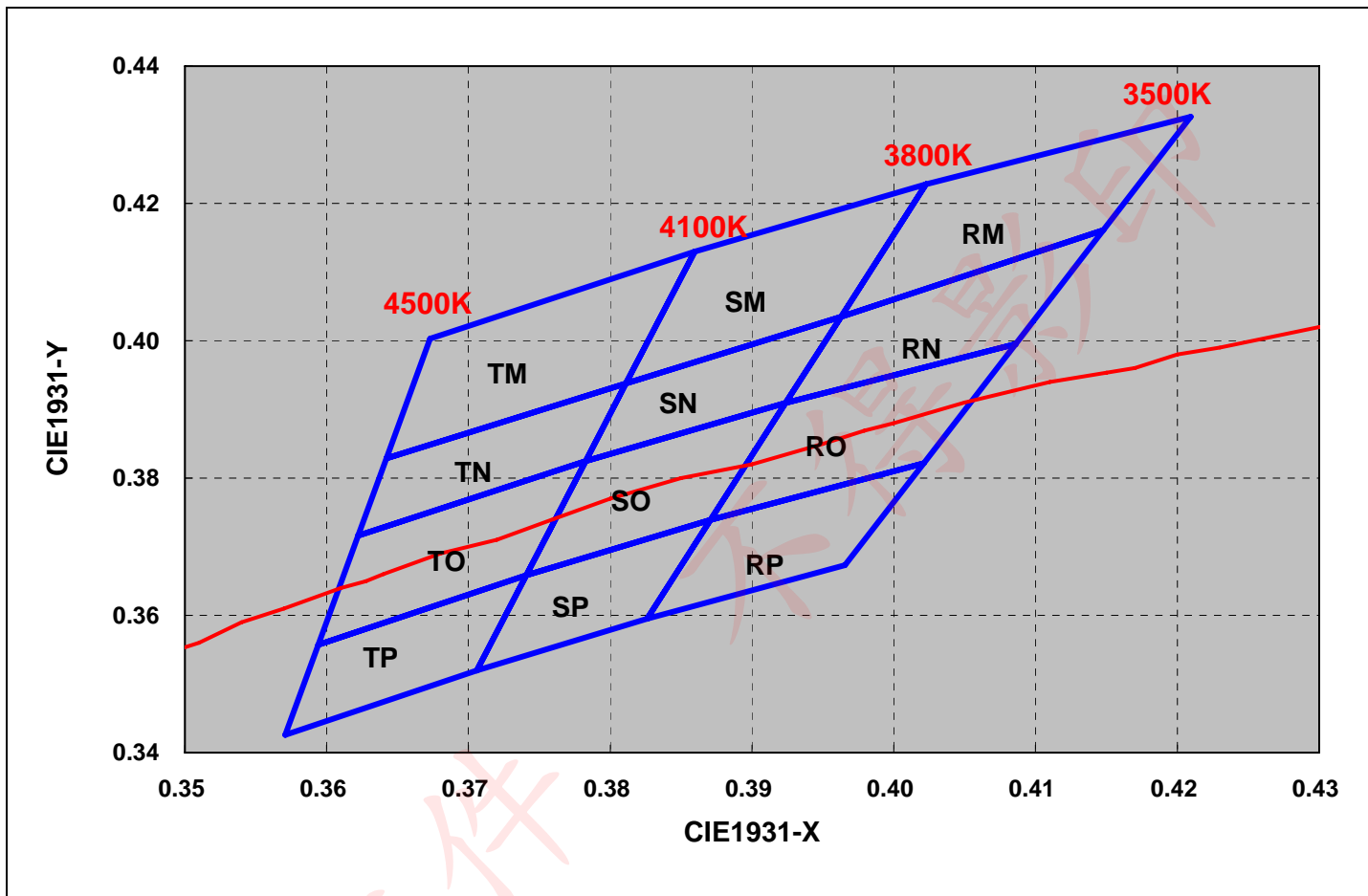

Fig. 2B Neutral-White Bin Structure.

Warm-white→S color

Bin Code	X	Y	CCT(K)	Bin Code	X	Y	CCT(K)	Bin Code	X	Y	CCT(K)
QM	0.4209	0.4326	3250~3500	PO	0.4240	0.4065	3000~3250	MM	0.4705	0.4508	2670~2850
	0.4385	0.4404			0.4376	0.4116			0.4866	0.4542	
	0.4312	0.4234			0.4294	0.3943			0.4767	0.4366	
	0.4148	0.4161			0.4165	0.3890			0.4614	0.4333	
QN	0.4148	0.4161		PP	0.4165	0.3890		0.4614	0.4333		
	0.4312	0.4234			0.4294	0.3943		0.4767	0.4366		
	0.4240	0.4065			0.4221	0.3790		0.4671	0.4196		
	0.4086	0.3995			0.4100	0.3738		0.4525	0.4162		
QO	0.4086	0.3995		NM	0.4538	0.4460		MO	0.4525	0.4162	
	0.4240	0.4065			0.4705	0.4508			0.4671	0.4196	
	0.4165	0.3890			0.4614	0.4333			0.4577	0.4029	
	0.4021	0.3822			0.4456	0.4287			0.4436	0.3991	
QP	0.4021	0.3822	NN	0.4456	0.4287	MP	0.4436	0.3991			
	0.4165	0.3890		0.4614	0.4333		0.4577	0.4029			
	0.4100	0.3738		0.4525	0.4162		0.4490	0.3875			
	0.3966	0.3673		0.4376	0.4116		0.4356	0.3837			
PM	0.4385	0.4404	NO	0.4376	0.4116	2850~3000	NP	0.4294	0.3943		
	0.4538	0.4460		0.4525	0.4162			0.4436	0.3991		
	0.4456	0.4287		0.4436	0.3991			0.4356	0.3837		
	0.4312	0.4234		0.4294	0.3943			0.4221	0.3790		
PN	0.4312	0.4234	NP	0.4294	0.3943		NP	0.4294	0.3943		
	0.4456	0.4287		0.4436	0.3991			0.4436	0.3991		
	0.4376	0.4116		0.4356	0.3837			0.4356	0.3837		
	0.4240	0.4065		0.4221	0.3790			0.4221	0.3790		

Warm-White Bin Structure

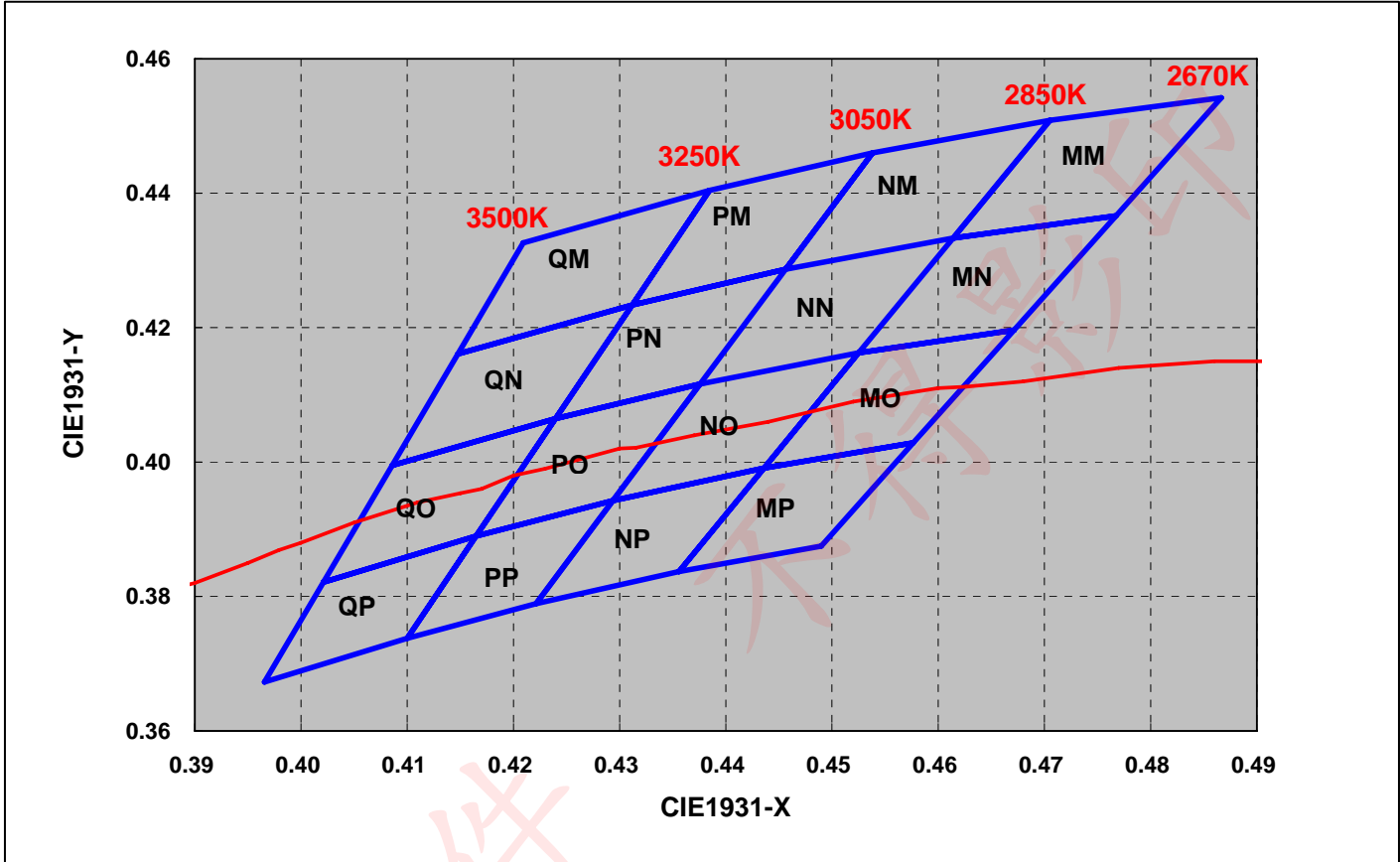

Fig. 2C Warm-White Bin Structure.

Note: The CIE1931 x, y color coordinates measurement allowance is ± 0.01 .

● Hue Bin Specification for Red, Green, Blue, Amber, Orange

Name	Code	λ_p Max (nm)	λ_p Min (nm)
Royal Blue	D0	440	445
	D1	445	450
	D2	450	455
	D3	455	460
Name	Code	λ_d Max(nm)	λ_d Min(nm)
Blue	B1	460	465
	B2	465	470
	B3	470	475
	B4	475	480
	B5	480	485
	B6	485	490
Cyan	C1	490	495
	C2	495	500
	C3	500	505
	C4	505	510
	C5	510	515

Name	Code	λ_d Max(nm)	λ_d Min(nm)
Green	G1	515	520
	G2	520	525
	G3	525	530
	G4	530	535
	G5	535	540
	G6	540	545
	G7	545	550
Amber	A1	584.5	587
	A2	587	589.5
	A4	589.5	592
	A6	592	594.5
	A7	594.5	597
Red & Orange	R1	605	610
	R2	610	615
	R3	615	620
	R4	620	625
	R5	625	630
	R6	630	635
	R7	635	640

Note: Wavelength measurement allowance is $\pm 2\text{nm}$

Part Number Formation

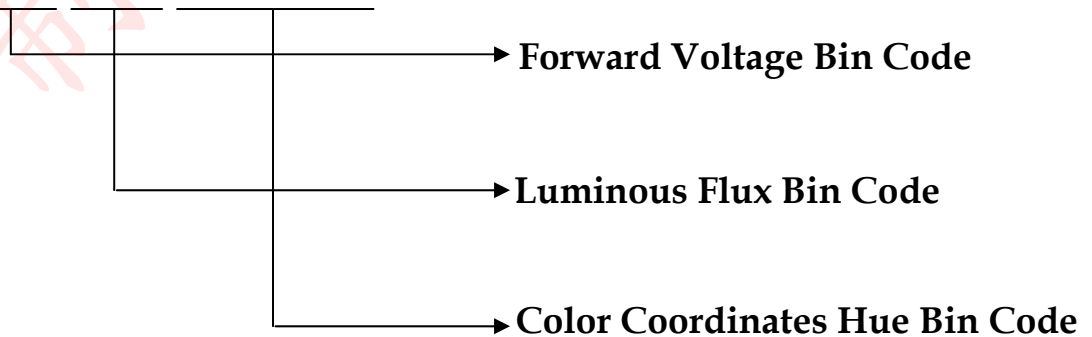
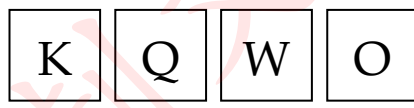
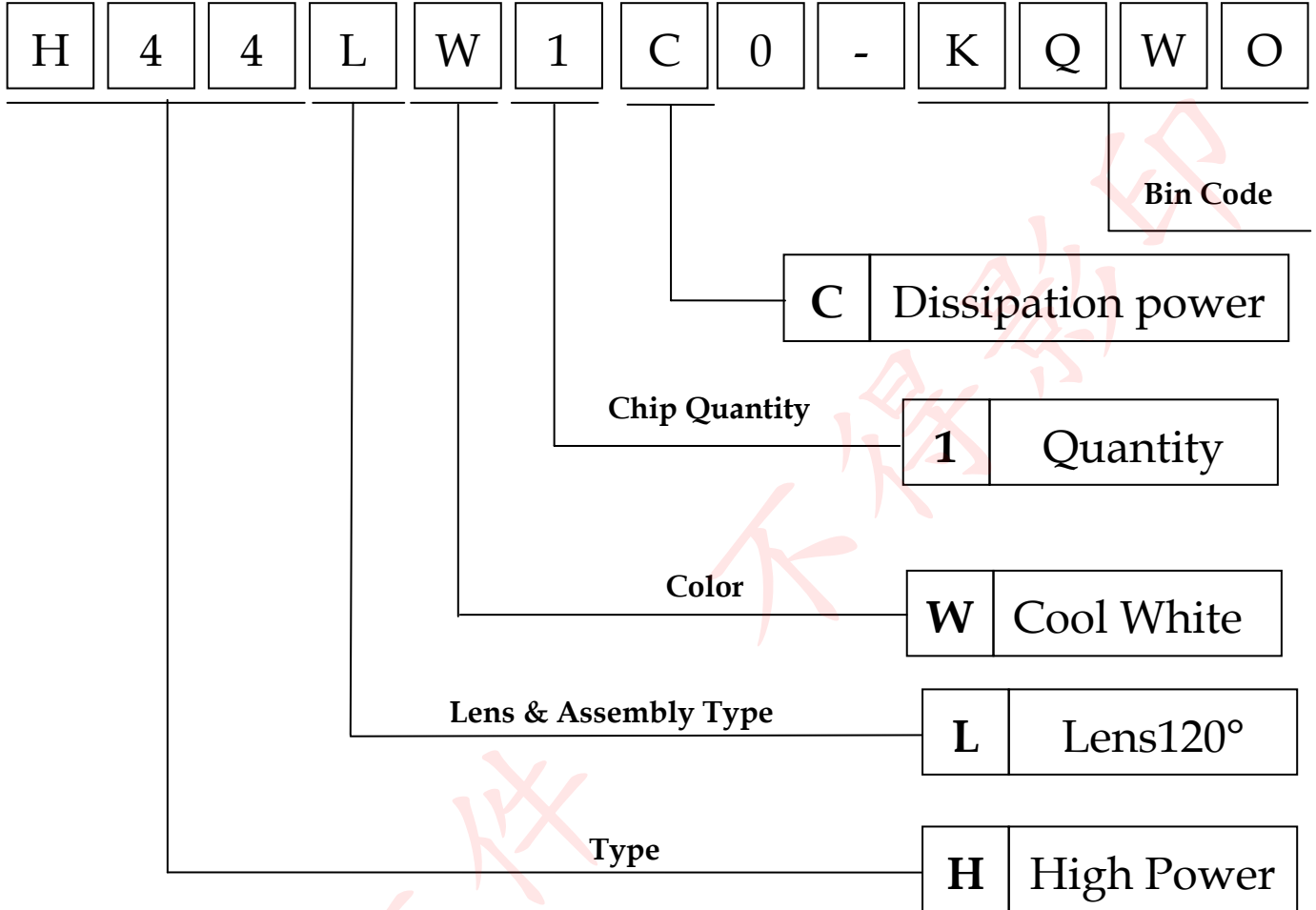

Characteristic Diagram

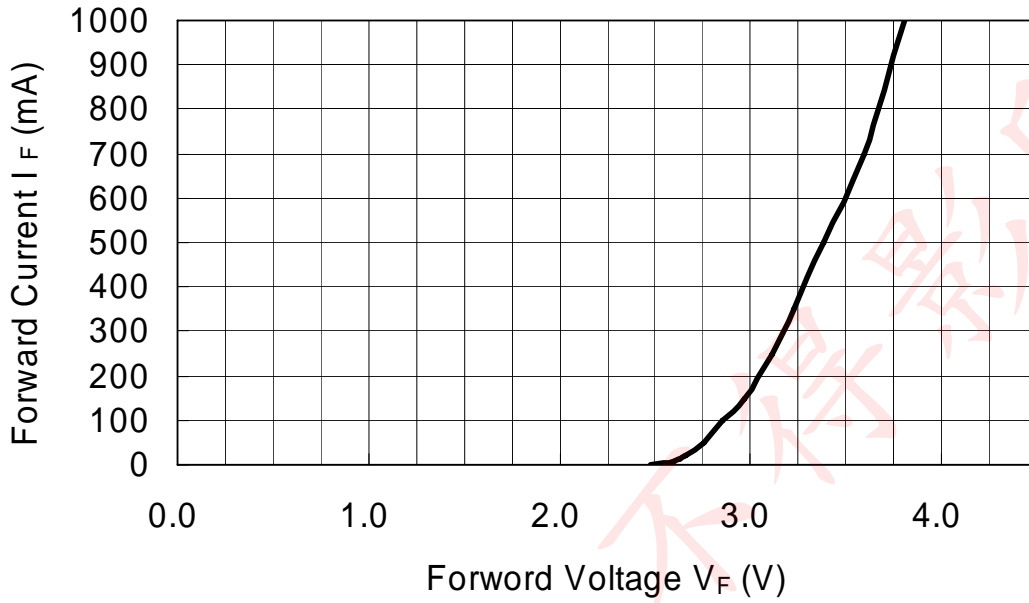

Fig. 3A Forward Current vs. Forward Voltage: Cool White/ Neutral White/ Warm White/ Blue/ Green color.

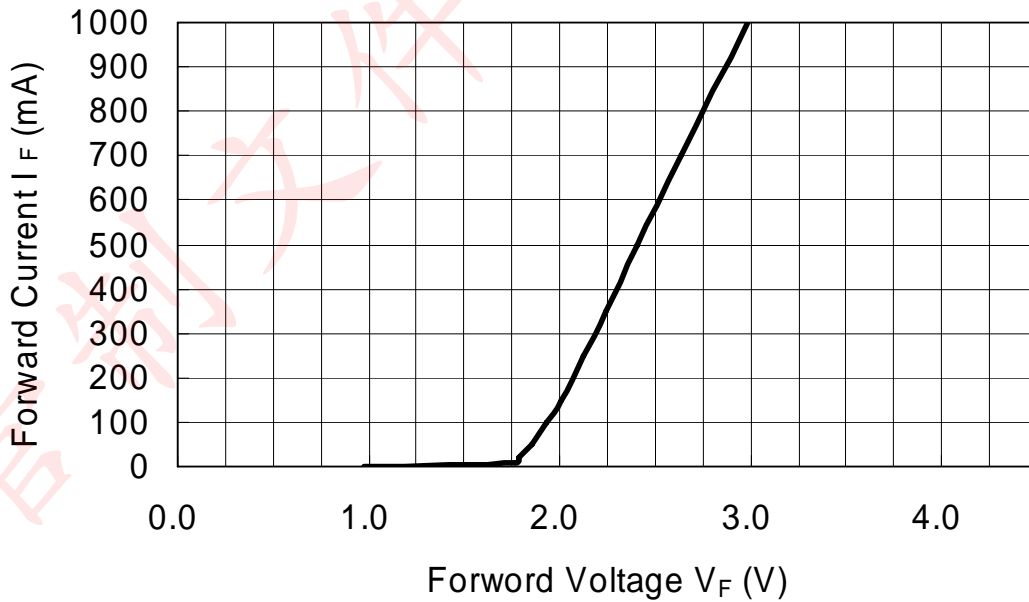

Fig. 3B Forward Current vs. Forward Voltage: Red/Amber/Orange color.

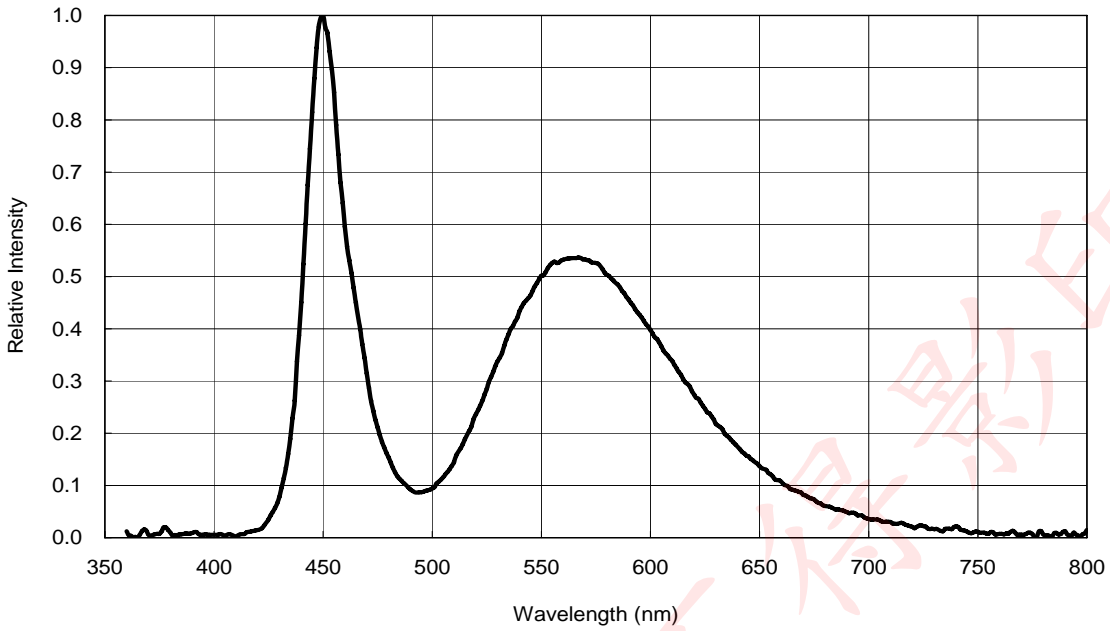

Fig. 4A Relative Intensity vs. Wavelength: Cool White.

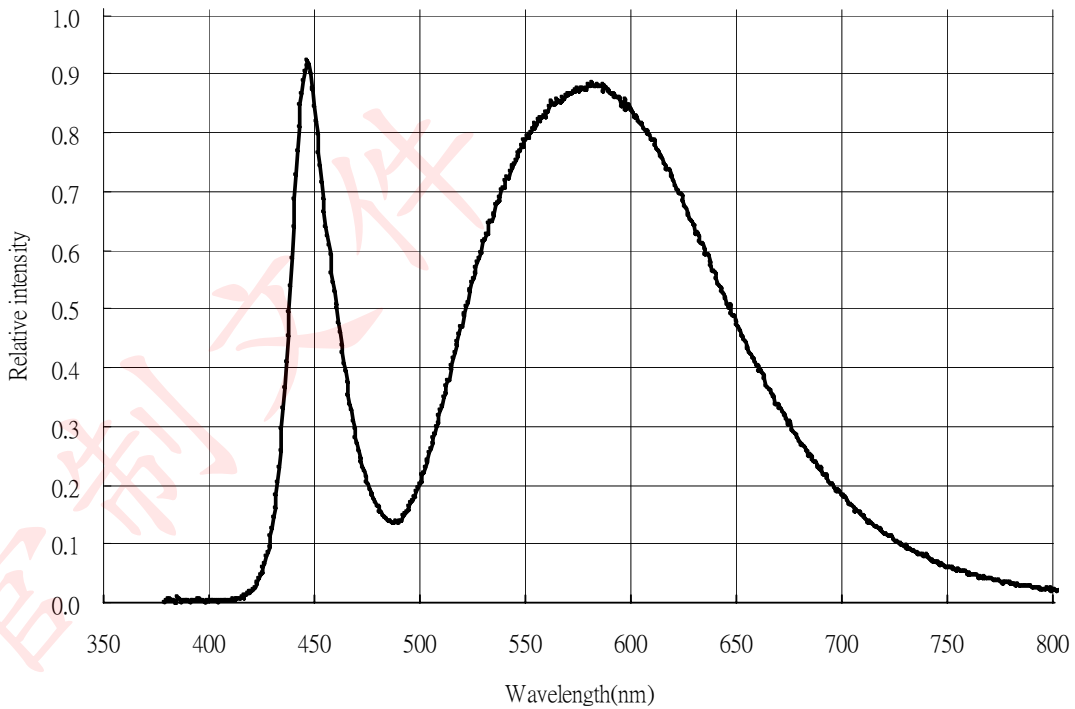

Fig. 4B Relative Intensity vs. Wavelength: Nature White.

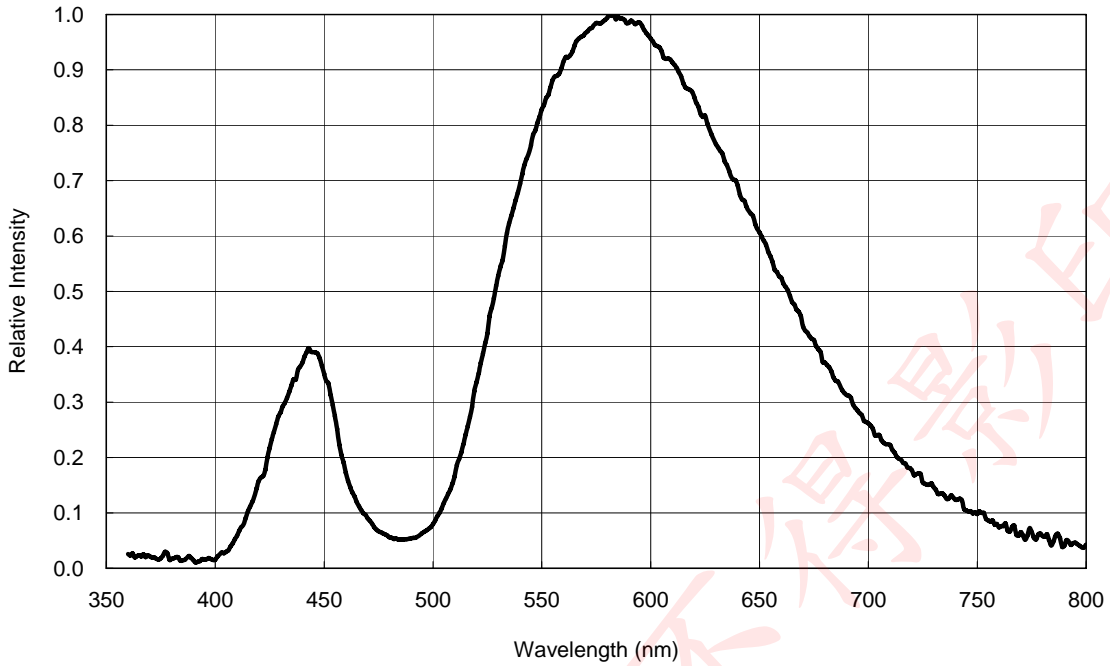

Fig. 4C Relative Intensity vs. Wavelength: Warm White.

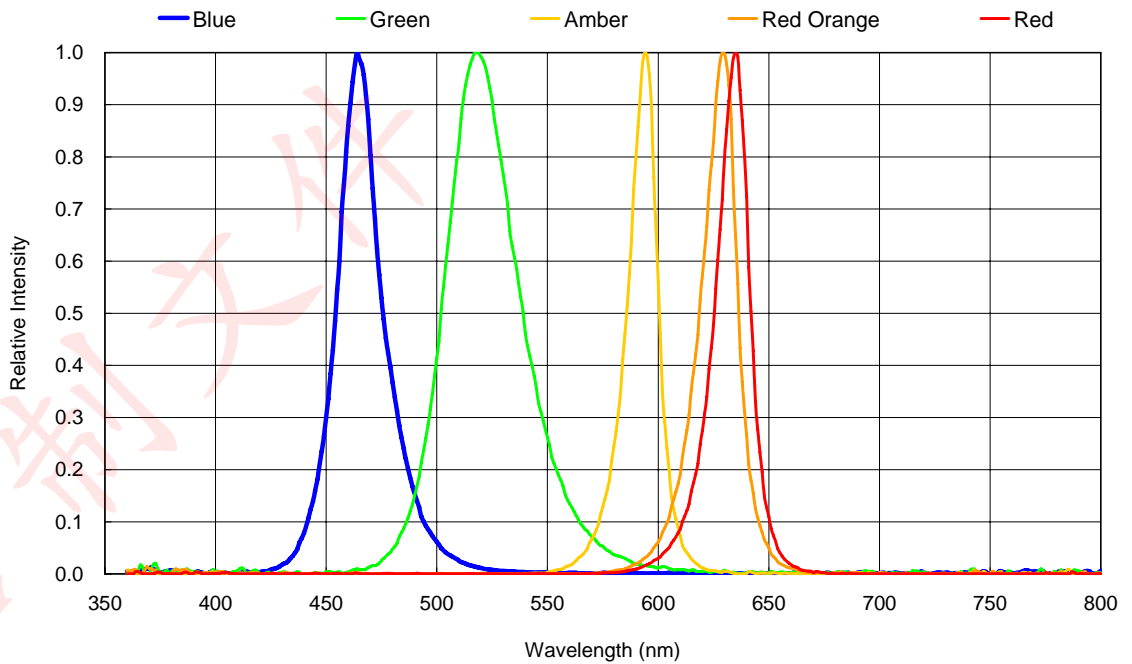

Fig. 4D Relative Intensity vs. Wavelength: Single Color.

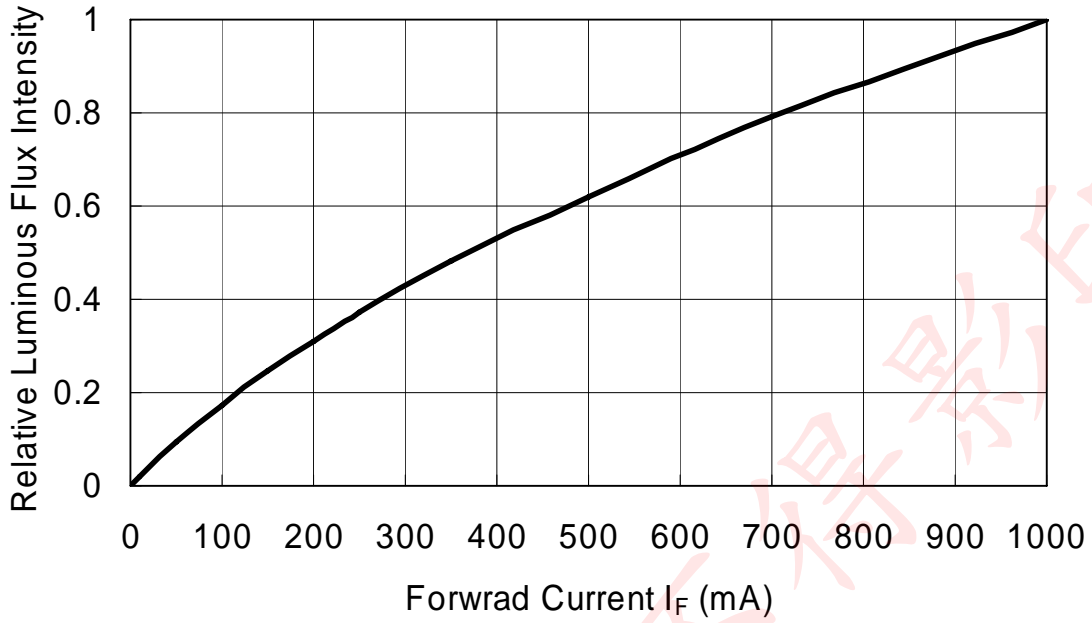
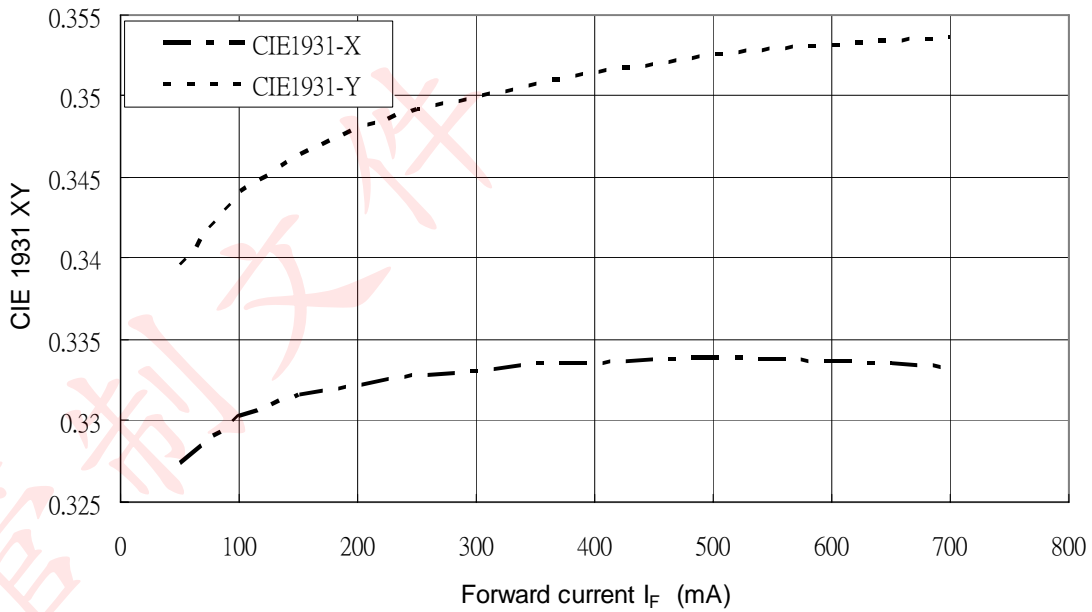

Fig. 5 Relative Intensity vs. Forward Current.



Depends on the phosphor, the performance of the LEDs may vary.

Fig. 6 Forward Current vs. CIE1931 X,Y.

Outline Dimension

Unit : mm

HPL-H44LX1BA

HPL-H44RX1BA

HPL-H44DX1BA

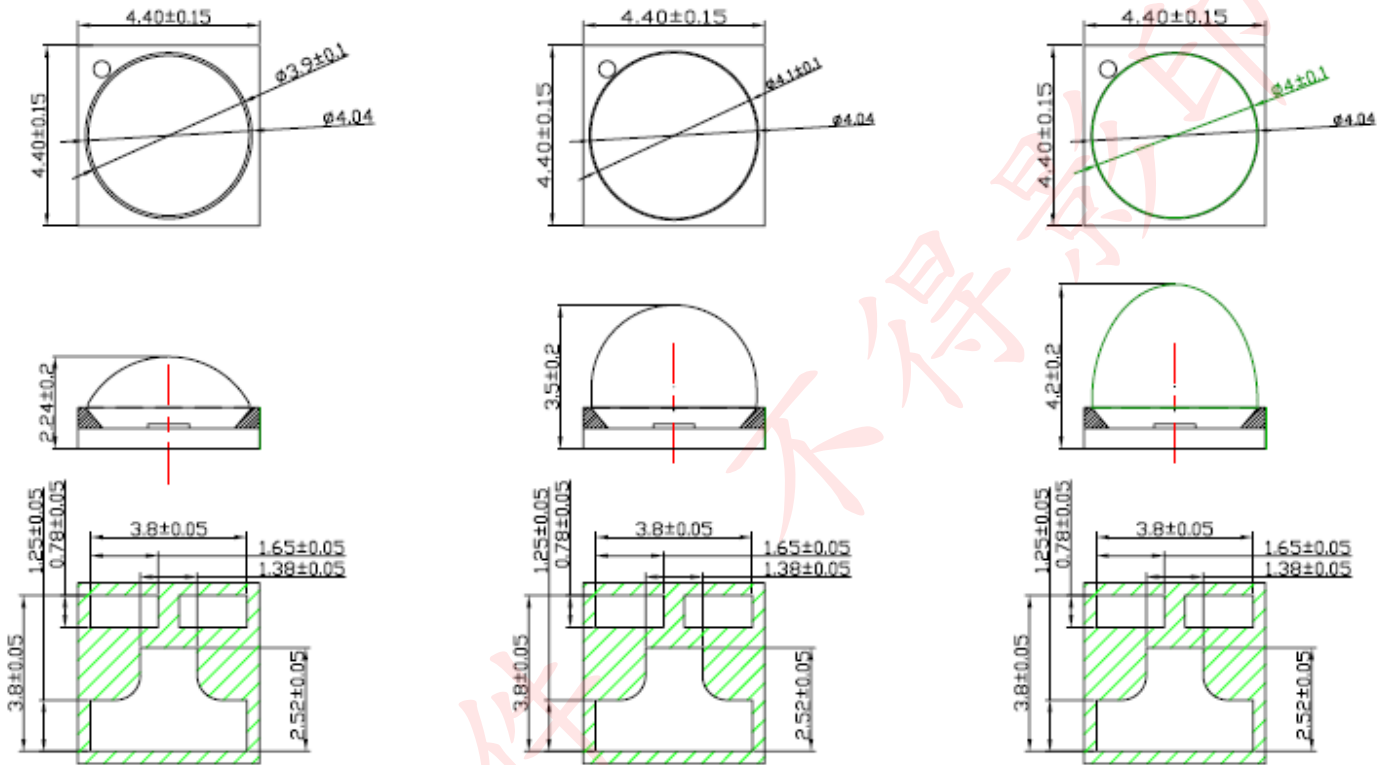
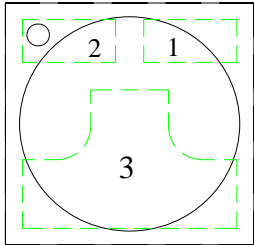
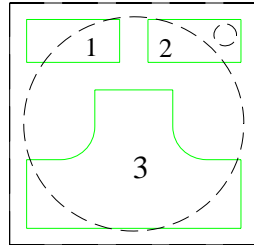

Fig7. Package Outline Drawing.

● Pad Configuration



TOP



BOTTOM

PAD	Function
1	Cathode
2	Anode
3	Thermal

Fig8. Pad configuration.

HPL-H44XX1C0

HPL-H44TX1C0

HPL-H44FX1C0

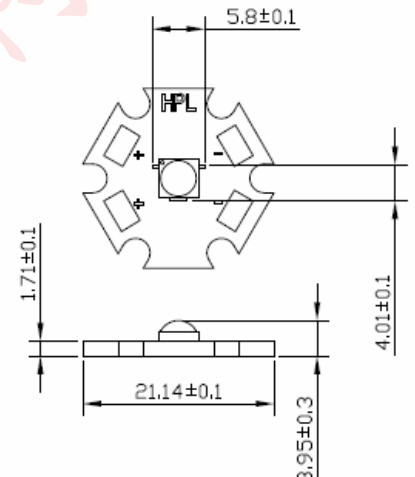
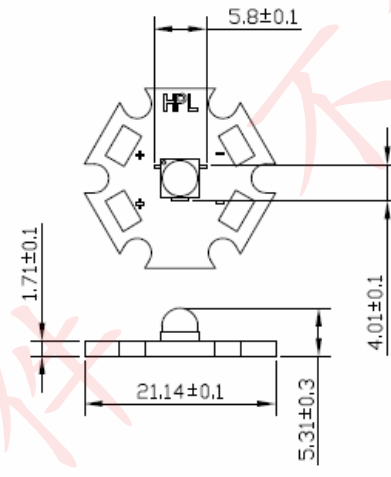
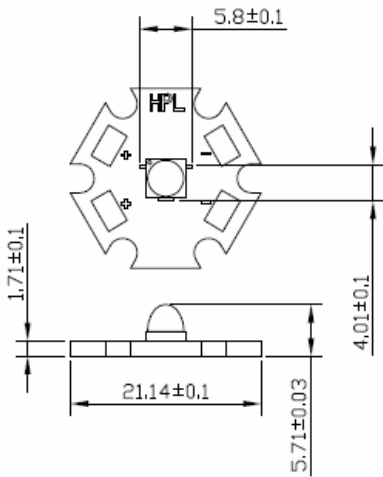
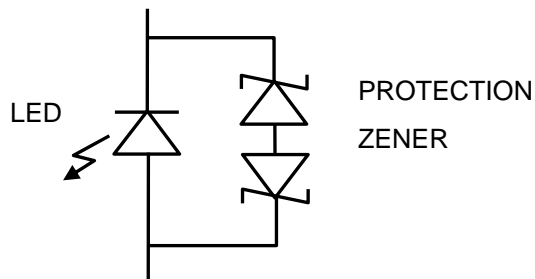

Fig9. Assembly and Outline Drawing.

PROTECTION CIRCUIT



Recommended Solder Pattern

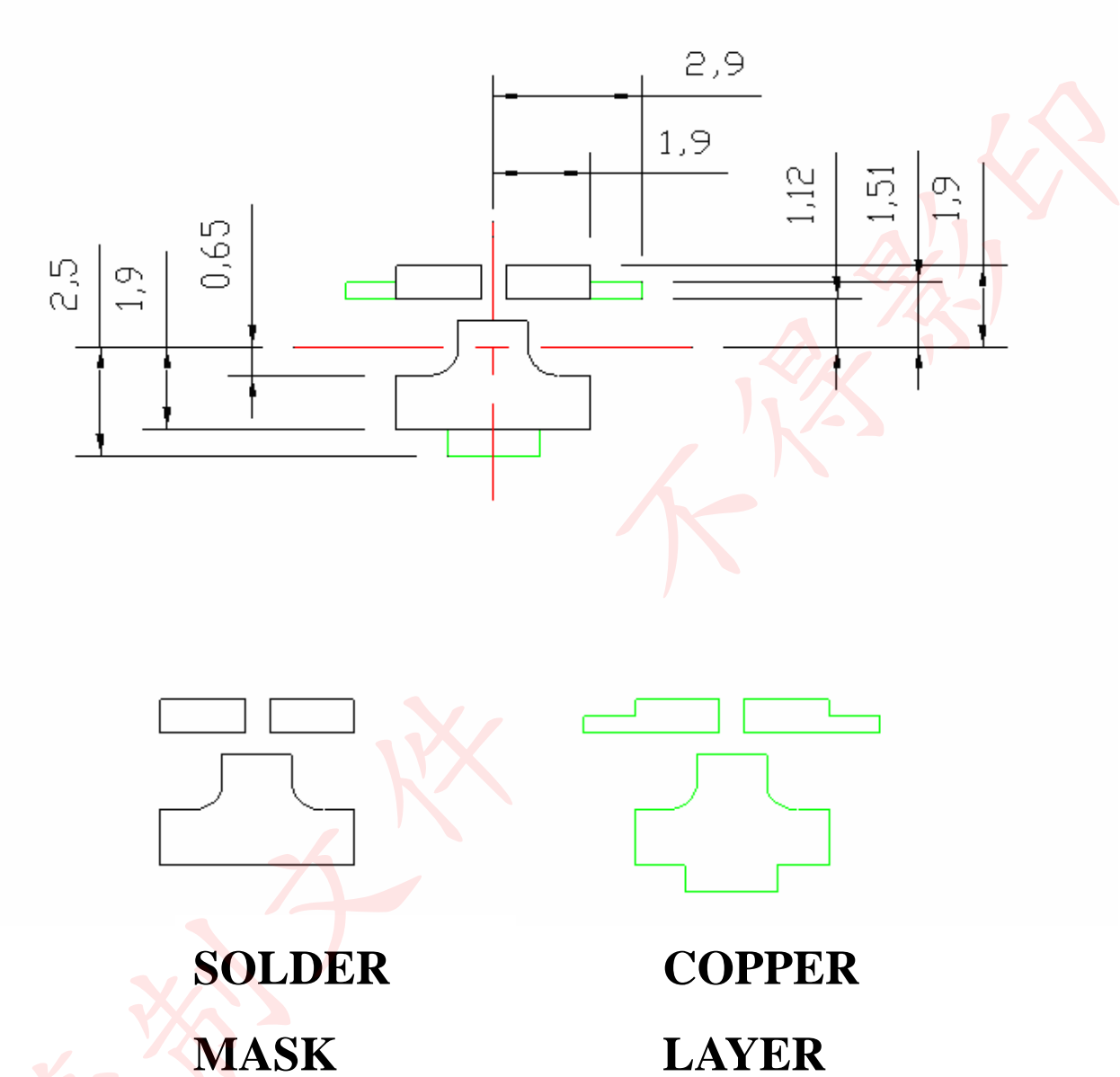

Fig.10 Solder Pad Layout.

Shipping Package Style

Lens Type

Tapping Dimension Packaging Specification

60 Degree Lens Type :

- Moisture proof bag.
- 1 Reel/bag.
- Q'ty: 650 (MAX)/Reel.

Unit : mm

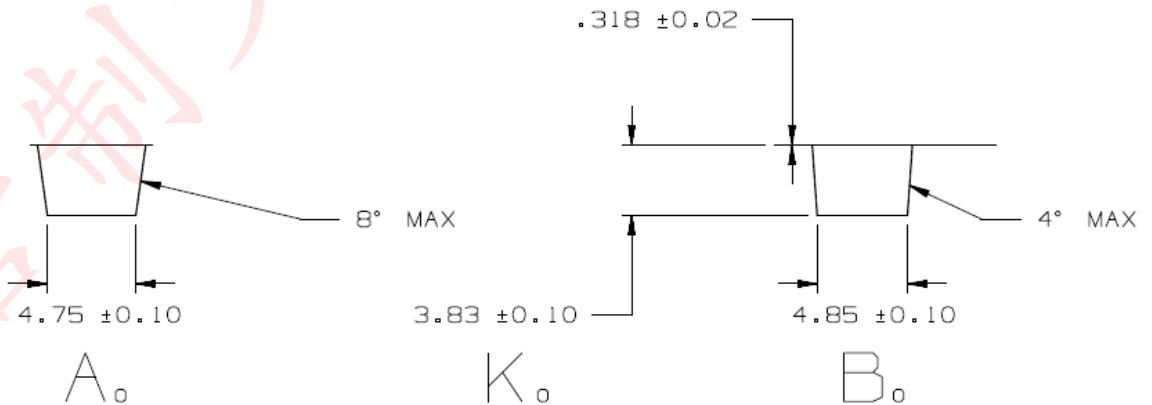
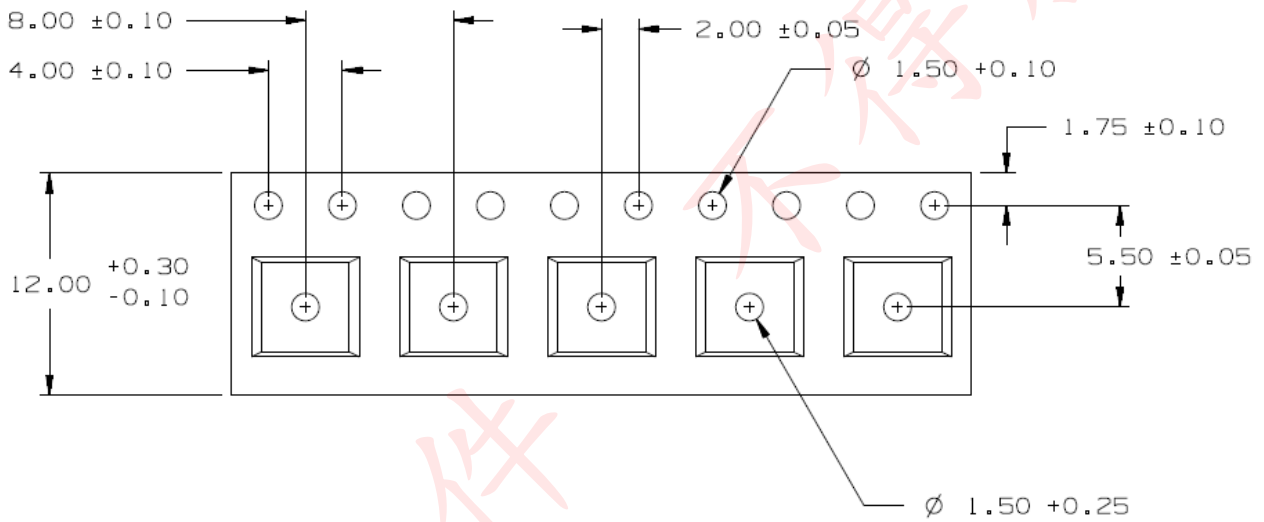

120 Degree Lens Type :

- Moisture proof bag.
- 1 Reel/bag.
- Q'ty: 800(MAX)/Reel.

Unit : mm

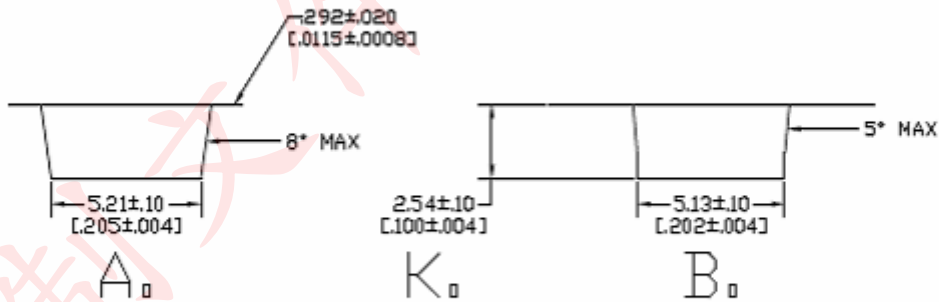
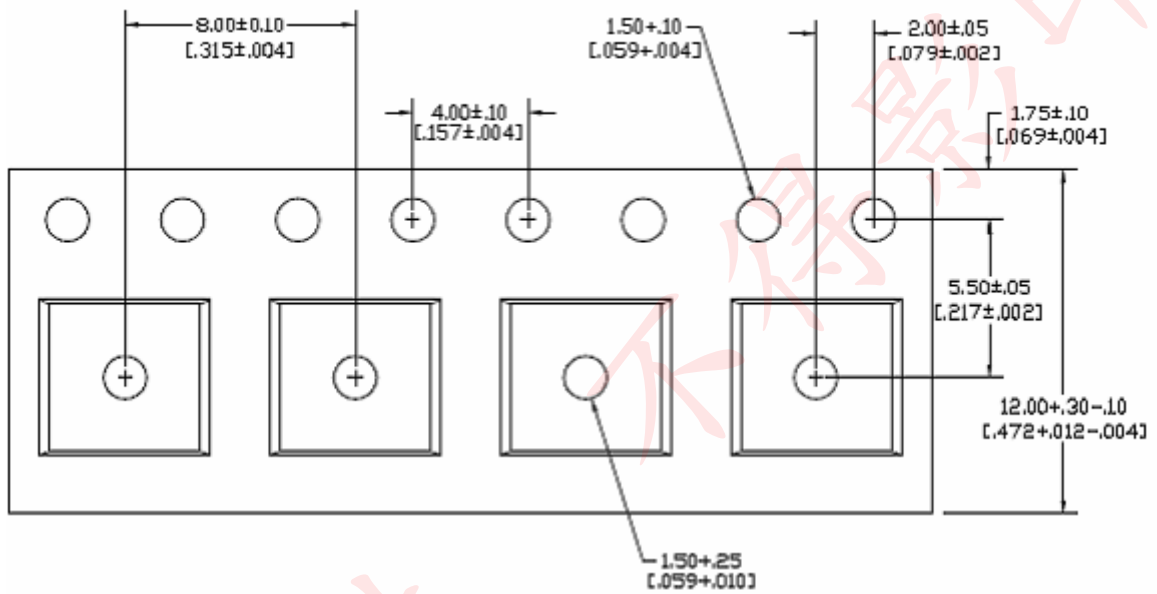

MM
[INCH]

30 Degree Lens Type :

- 1 Tube
- Q'ty: 100(MAX)/Tube.
- Q'ty: 950 Tube (MAX)/Box.

Unit : mm

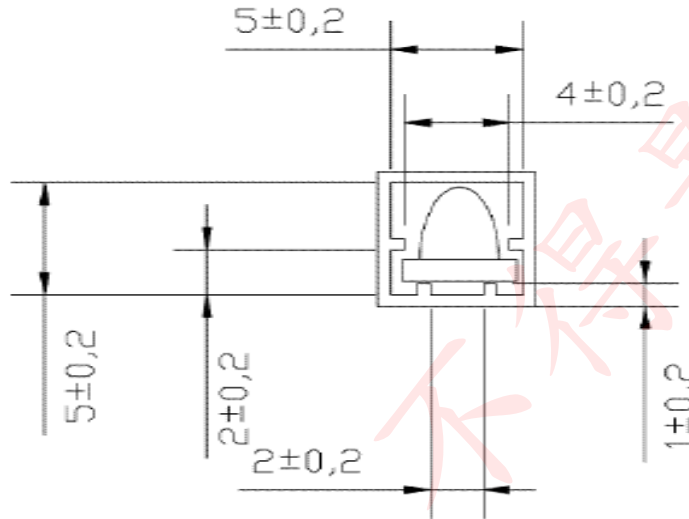

NOTES:
 General tolerance = $\pm 0.20\text{mm}$
 Material : PVC, Clear
 THICKNESS : 0.5mm
 LENGTH : $460\text{mm} \pm 2\text{mm}$

Label Formation

P/N: XXXXXXXXXXXXX	BIN Rank : XXXXXXXXX
LOT: XXXXXXXXXXXXX	Q'ty : XXXX PCS XXX

75mm*8mm

Package

Box Type	Dimension (mm)	Reel/Box	60°Lens Type (Pcs)	120°Lens Type(Pcs)
Small Box(S)	230x85x265	5 Reel/Box	3250	4000
Middle Box(M)	470x265x270	30 Reel/Box	19500	24000
Large Box(L)	470x435x270	50 Reel/Box	32500	40000

Reel Packaging :

Reel Part :

Unit : mm

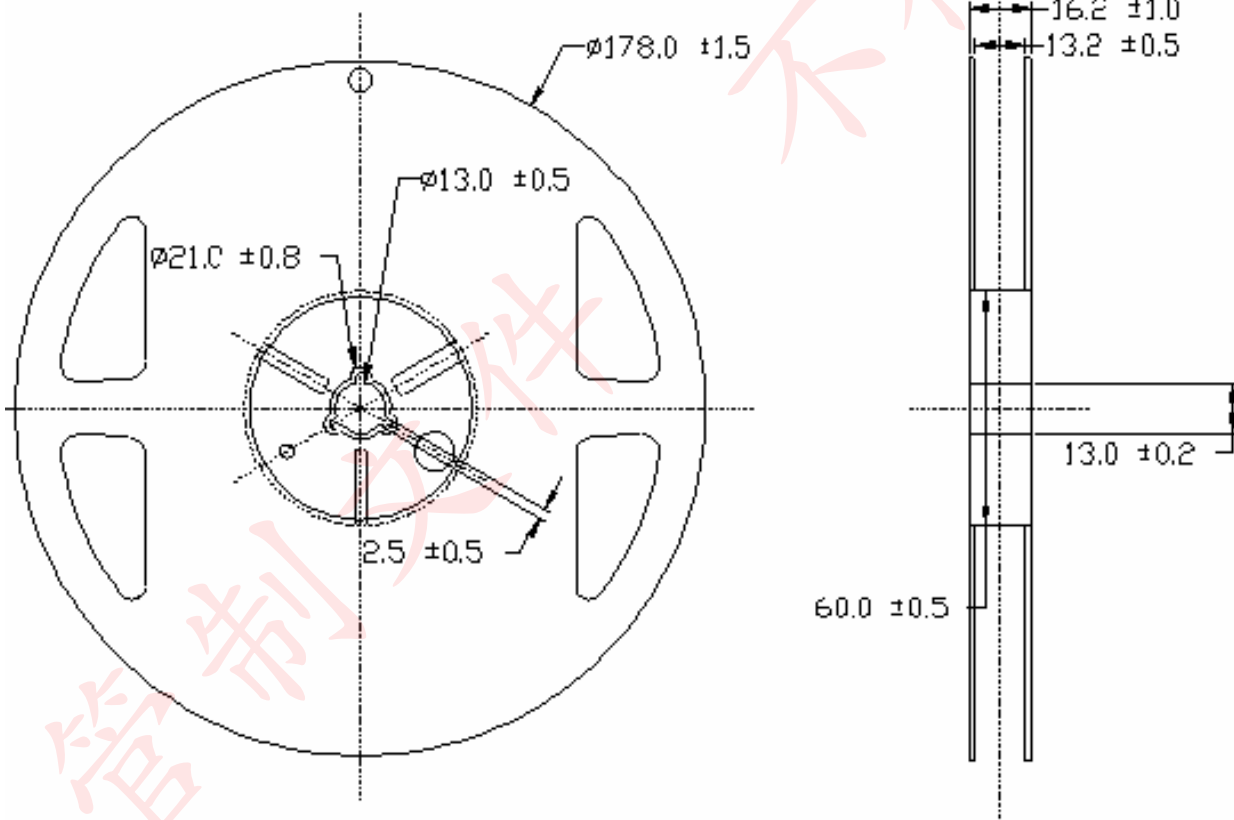

Anti Statistic Bag :

Unit : mm

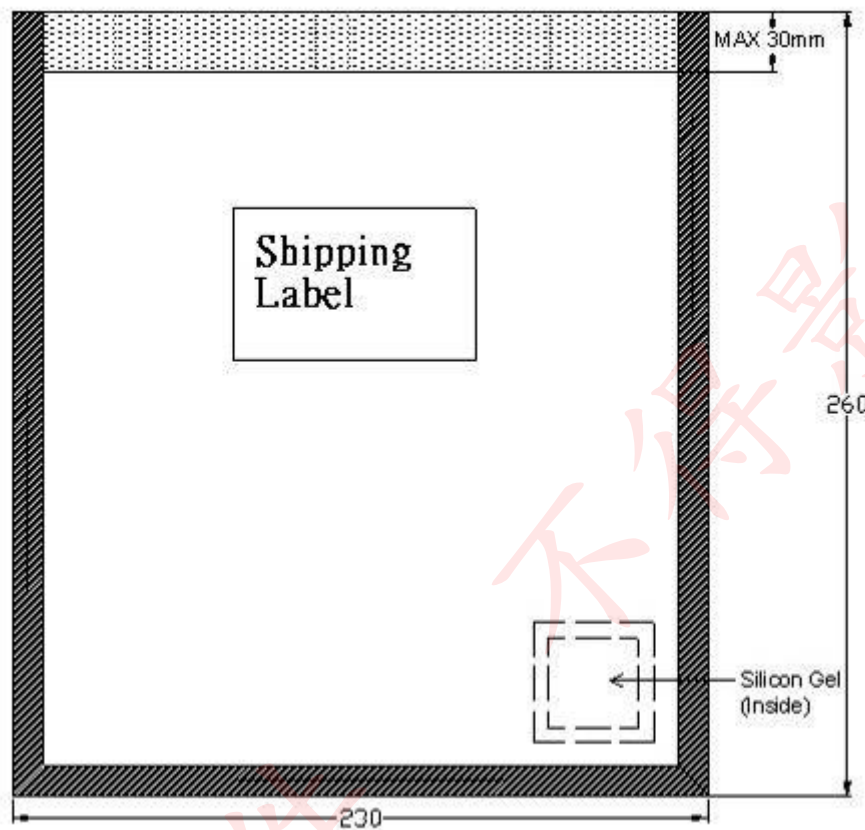

Small Box

Unit : mm

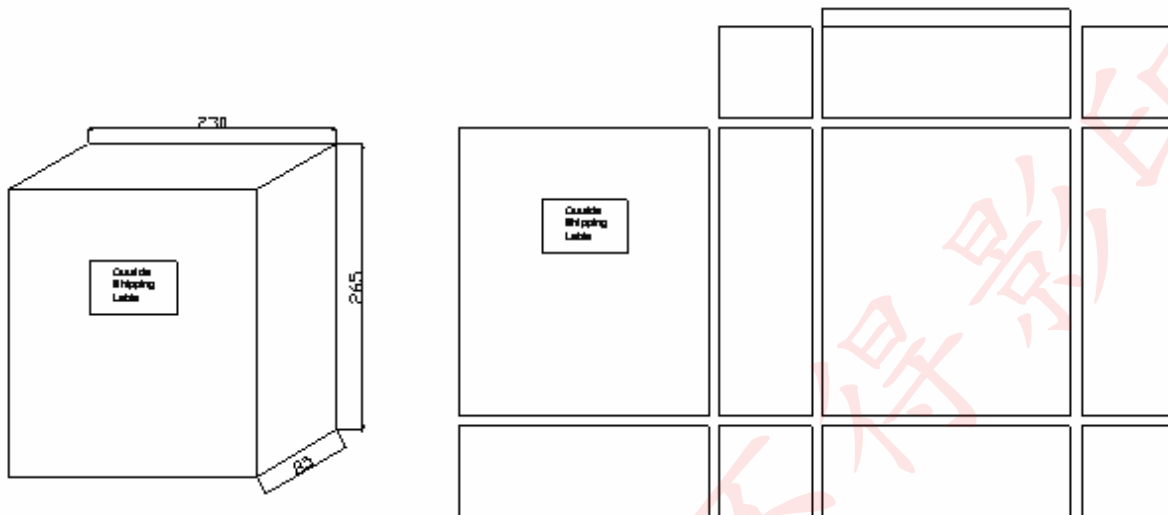

Middle Box

Unit : mm

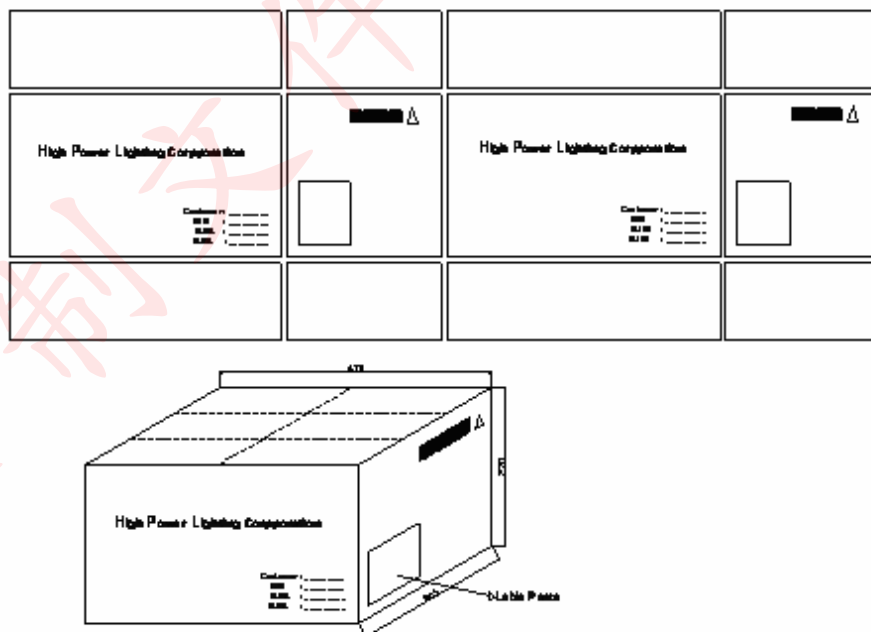

Large Box

Unit : mm

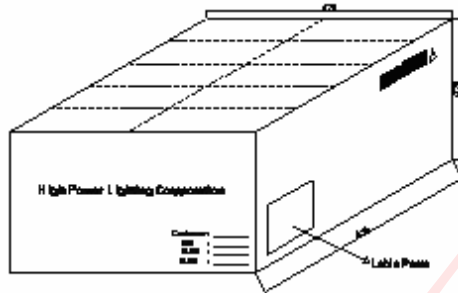
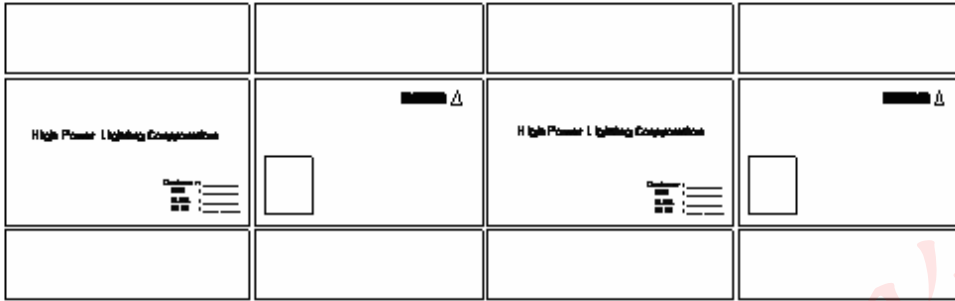

Label Formation

70mm

Unit : mm



40mm

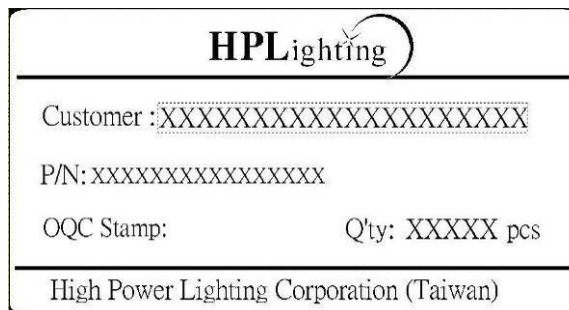

Assembly Type

Tapping Dimension Packaging Specification 30, 60 & 120 Degree Assembly Type :

- Moisture proof bag.
- 21 Tray (MAX) /bag.
- Q'ty: 48pcs(MAX)/Tray

Unit : mm

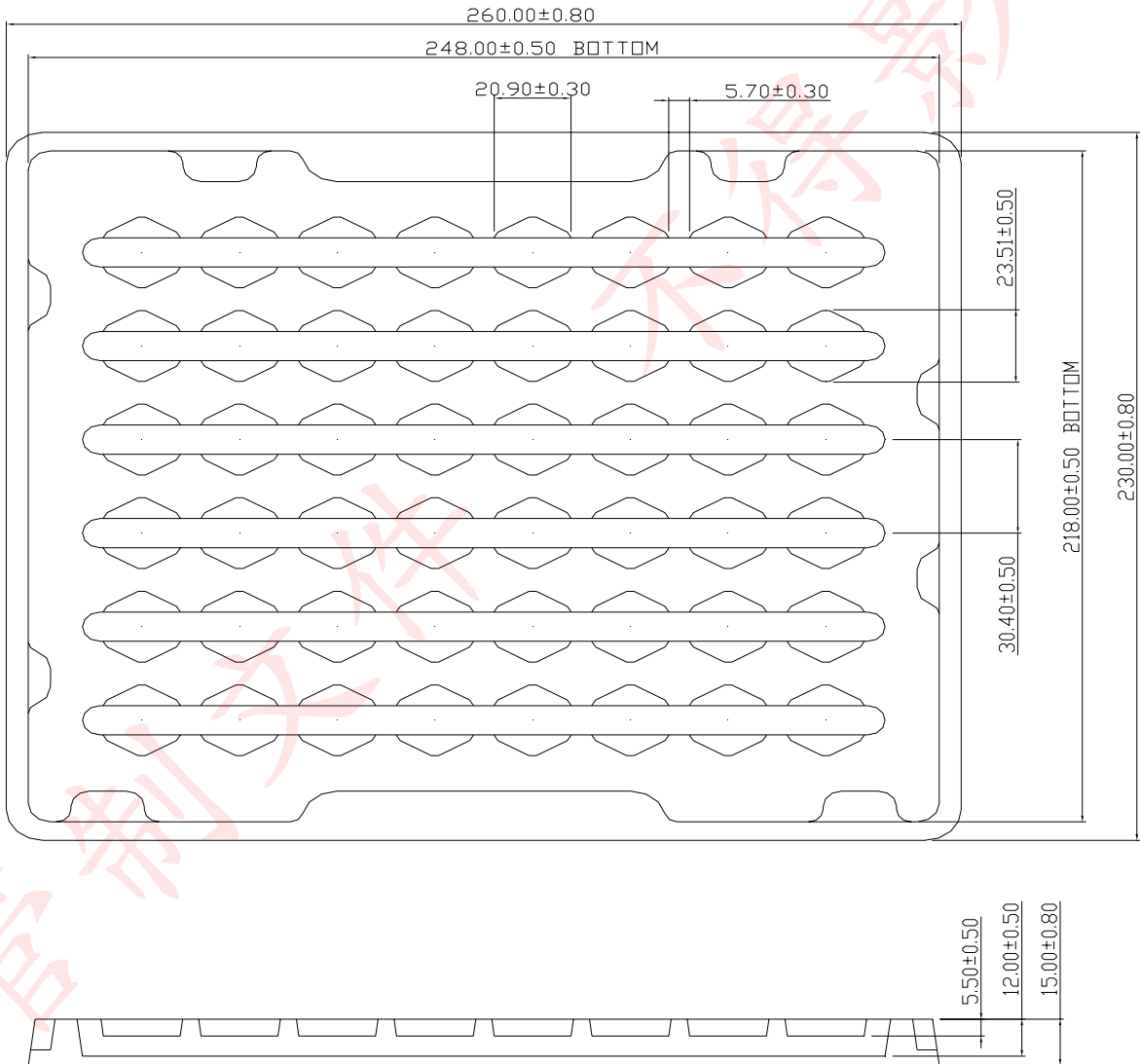

30, 60 & 120 Degree Assembly Type :

- 1 Tube
- Q'ty:20pcs(MAX)/Tube
- Q'ty: 300 Tube (MAX)/Box

Unit : mm

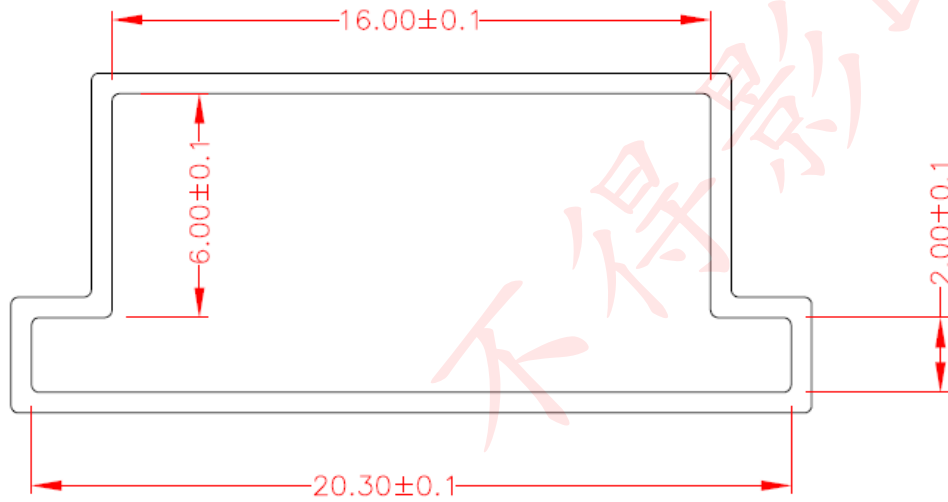

NOTES:

General tolerance = ± 0.10 mm
Material : PVC, Clear
THICKNESS : 0.55 ± 0.05
LENGTH : 424 ± 2 MM

Label Formation

P/N: XXXXXXXXXXXXX	BIN Rank : XXXXXXXXX
LOT: XXXXXXXXXXXXX	Q'ty : XXXPCS XXX

75mm*8mm

**Package
Large Box**

Unit : mm

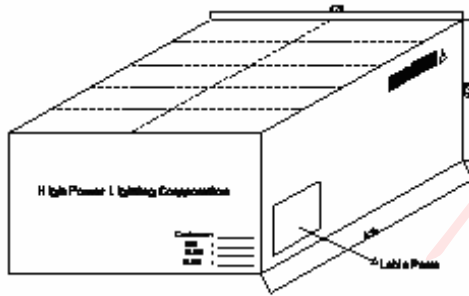
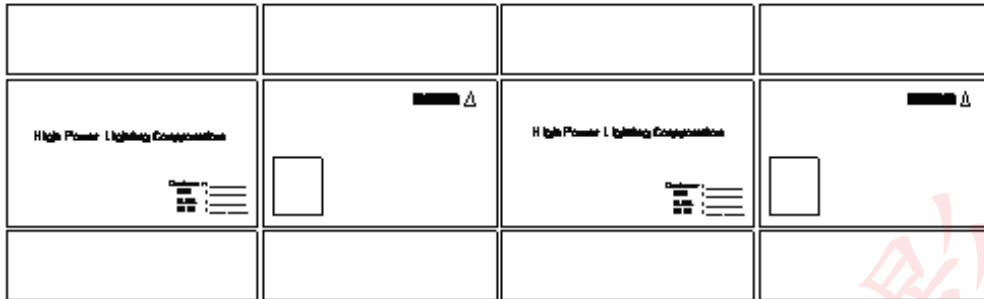

Label Formation

70mm

Unit : mm



40mm

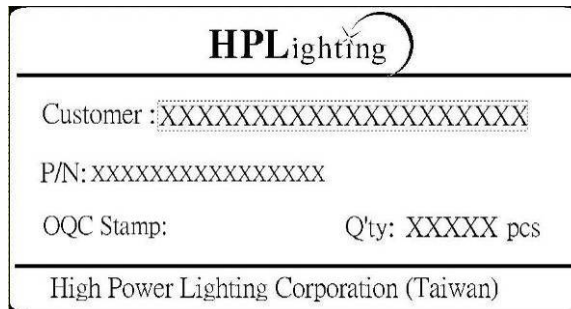

Qualification Reliability Testing

Classification	Test Item	Test conditions	Reference Standard
Endurance Test	Operation Life	$I_f = 60\text{mA}/120\text{mA}(\text{H28}), 350\text{mA}/700\text{mA}(\text{H40}/\text{H44}/\text{H99})$ $T_a = 25^\circ\text{C}$ Test Duration = 1000hrs	MIL-STD-750: 1026 MIL-STD-883: 1005 JIS C 7021: B-1
	High Temperature High Humidity Storage	$I_f = 60\text{mA}/120\text{mA}(\text{H28}), 350\text{mA}/700\text{mA}(\text{H40}/\text{H44}/\text{H99})$ $T_a = 85\pm 5^\circ\text{C}$ RH = 85±5% Test Duration = 1000hrs	MIL-STD-202: 103B JIS C 7021: B-11
	High Temperature Storage	$T_a = 105\pm 5^\circ\text{C}$ Test Duration = 1000hrs	MIL-STD-202: 1008 JIS C 7021: B10
	Low Temperature Storage	$T_a = -40\pm 5^\circ\text{C}$ Test Duration = 1000hrs	JIS C 7021: B-12
Environmental Test	Temperature Cycling	$-40^\circ\text{C} \sim 25^\circ\text{C} \sim 105^\circ\text{C} \sim 25^\circ\text{C}$ 30min 5min 30min 5min Test Duration = 10 cycle	MIL-STD-202: 107D MIL-STD-750: 1051 MIL-STD-883: 1010 JIS C 7021: A-4
	Thermal Shock	$-55\pm 5^\circ\text{C} \sim 105\pm 5^\circ\text{C}$ 30min 30min Test Duration = 10 cycle	MIL-STD-202: 107D MIL-STD-750: 1051 MIL-STD-883: 1011
	Solder Resistance	$T_{\text{sol}} = 260\pm 5^\circ\text{C}$ Dwell Time = 10sec	MIL-STD-202: 210A MIL-STD-750: 2031 JIS C 7021: A-1
Measuring Items	Symbol	Measuring Conditions	Failure Criteria
Forward voltage	V_f	$I_f = 60\text{mA}/120\text{mA}(\text{H28}), 350\text{mA}/700\text{mA}(\text{H40}/\text{H44}/\text{H99})$	V_f shift > 10%
Luminous	$I_v\%$	$I_f = 60\text{mA}/120\text{mA}(\text{H28}), 350\text{mA}/700\text{mA}(\text{H40}/\text{H44}/\text{H99})$	$I_v\%$ shift > 10%

Recommended Solder Profile

Soldering Recommended soldering conditions:

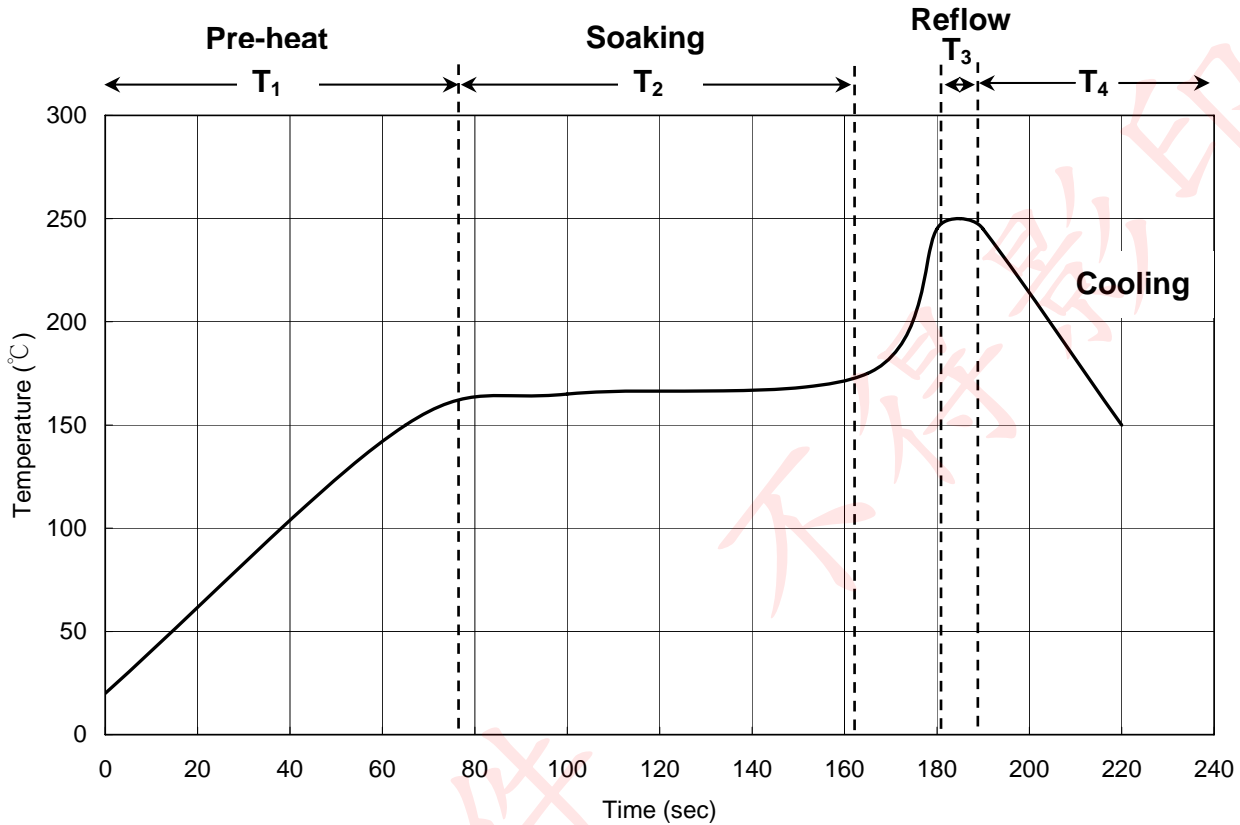

T ₁	Ramp up rate	1.0 ~ 3.0 °C/sec
	Pre-heat time	50 ~ 80 sec
T ₂	Soaking temperature	155 ~ 185 °C
	Dwell time during soaking	60 ~ 120 sec
T ₃	Reflow temperature	240 ~ 250 °C
	Reflow time	Max 10 sec
	Ramp up rate during reflow	1.2 ~ 2.3 °C/sec
T ₄	Cooling	1.0 ~ 6.0 °C/sec

Note: Suggest using Sn96Ag3Cu0.5 lead free solder.

Cleaning

Use alcohol-based cleaning solvents such as isopropyl alcohol to clean the LED if necessary.

This page is intended left blank.

For the latest product information, call us or visit: www.hplighting.com.tw

©2011, High Power Lighting Corporation(HPL), all rights reserved. This document contains information that is proprietary to HPL and may be duplicated in whole or in part by the original recipient for the internal business purposes only, provided that this entire notice appears in all copies. In accepting this document, the recipient agrees to make every reasonable effort to prevent unauthorized use of this information.

5F, No 173-8, Yung-Fon Road, Tu-Cheng District, New Taipei City, Taiwan, R.O.C.
TEL: +886-2-8262-8886 FAX : +886-2-8262-8885